

Panasonic

Telephone Answering System
with Facsimile

KX-F2350NZ

Model No. **KX-F2450NZ**

Operating Instructions



The pictured model is KX-F2450NZ.

Please read these Operating Instructions before using the product.

*Thank you for purchasing the Panasonic Telephone Answering System with Facsimile.
Before using the unit, please read these Operating Instructions completely.
You can then easily install, configure and operate the unit properly.
This unit combines multiple functions of Facsimile, Answering Device and Telephone;
you can send and receive voice-messages and documents on a single line.*

MODEL VARIATION

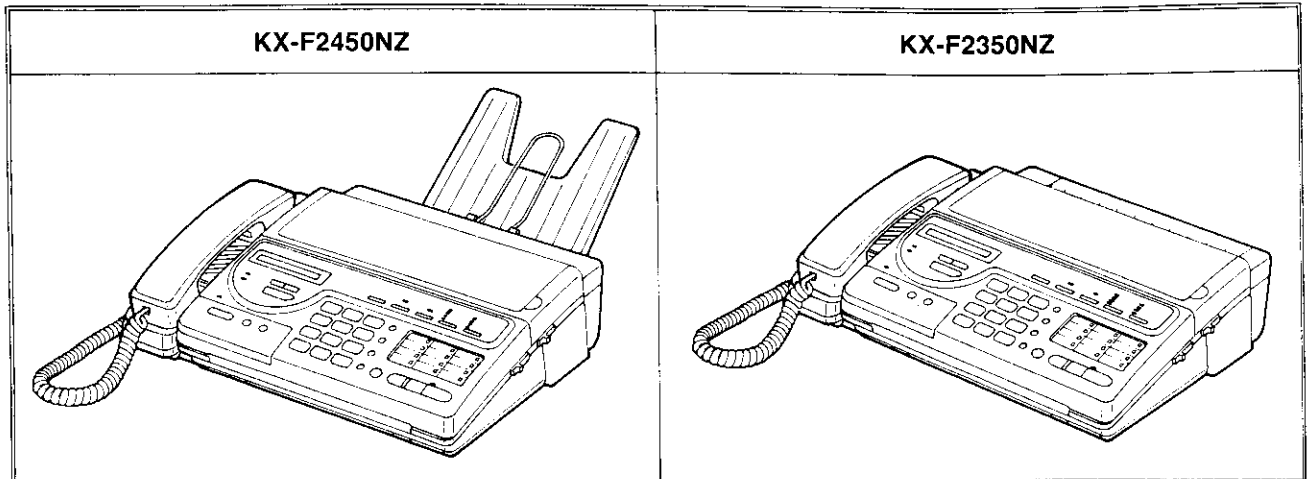

The model KX-F2450NZ is the machine that is equipped with the automatic paper cutter function. So the receiving tray and the diverter are provided only for the model KX-F2450NZ.

GETTING HELP FROM YOUR UNIT:

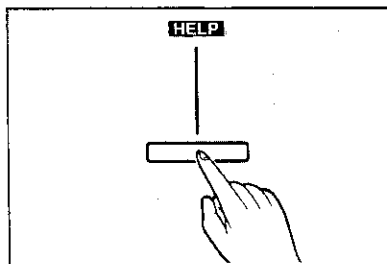

If you press the **HELP** button

- while programming, the unit will print information about the operation.
- in idle status, the unit will print information about how to send documents, how to set up, etc.

WARNING

WHEN A FAILURE OCCURS WHICH RESULTS IN THE INTERNAL PARTS BECOMING ACCESSIBLE, DISCONNECT THE POWER SUPPLY CORD IMMEDIATELY AND RETURN THIS UNIT TO AN AUTHORIZED SERVICE CENTER.

DISCONNECT THE TELECOM CONNECTION BEFORE DISCONNECTING THE POWER CONNECTION PRIOR TO RELOCATING THE EQUIPMENT, AND RECONNECT THE POWER FIRST.

THE POWER SOCKET WALL OUTLET SHOULD BE LOCATED NEAR THIS EQUIPMENT AND BE EASILY ACCESSIBLE.

TO PREVENT FIRE OR SHOCK HAZARD, DO NOT EXPOSE THIS PRODUCT TO RAIN OR ANY TYPE OF MOISTURE.

Precaution

Keep the unit away from heating appliances such as radiators or air conditioning units.

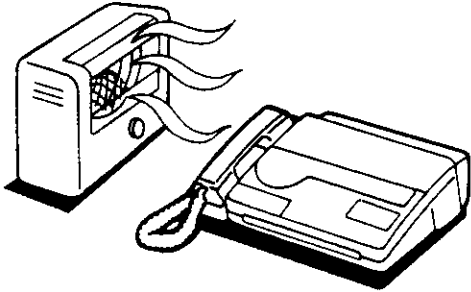

Keep the unit away from electrical noise generating devices such as fluorescent lamps and motors.

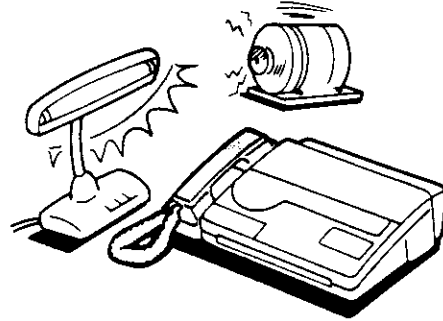

The unit and the cassette tape should not be exposed to direct sunlight.

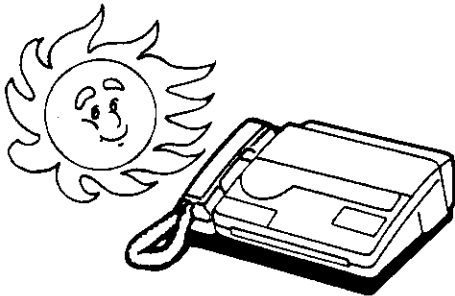

The unit and the cassette tape should be kept free from dust, moisture, high temperature and vibration.

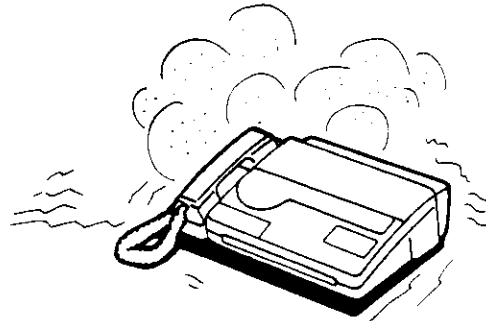

Do not use benzine, thinner, or the like, or any abrasive powder to clean the cabinet. Wipe it with a soft cloth.

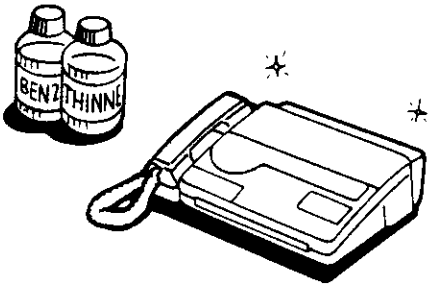

Do not place any covering over the unit while it is turned on.

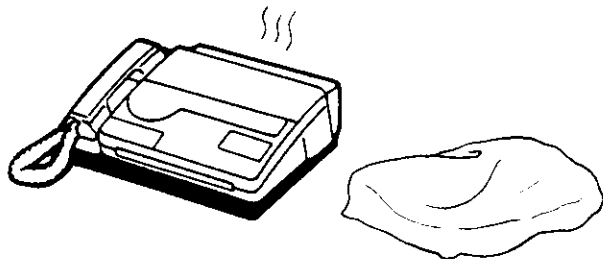

Introduction

Multi-function system using one telephone line

General

- Desktop type
- LCD readout
- Paper Curl Reduction Technology
- Automatic voice/facsimile switching
- Silent ring fax recognition system
- Copier function
- Automatic paper cutter (KX-F2450 only)
- Help function

Facsimile

- 15-second transmission speed*
- Sends/receives 216 mm × 600 mm pages at CCITT G3
- Automatic document feeder (up to 10 pages)
- One-touch sending buttons
- 16-level halftones
- Resolution: standard/fine/super fine/halftone
- Delayed transmission
- Network passcode communication
- Polling function
- Paper save function
- Extension copy

*Transmission times apply to text data using CCITT No. 1 test chart, between same machine models at maximum modem speed. Transmission times vary in actual usage.

Answering Device

- Recordable greeting message chip
- Auto-Logic operation for one-touch message playback
The unit automatically plays back all recorded messages or the new messages at the touch of the ALL MESSAGES or the NEW MESSAGES button and stops at the end of the last message, then resets to answer and record the next call.
- Remote control from touch tone telephone
- Message memo recording
- New message playback

Integrated Telephone System

- 12-station one-touch dialer
- 28-station speed dialer
- One-touch redial
- Hands-free speakerphone with mute

Four types of receiving modes

ANS/FAX mode:

When you wish to use the unit as a telephone answering device and a facsimile, or when your machine is unattended, select this mode. When a call is received during your absence, the unit records a voice-message and/or receives a document automatically depending on the caller's choice. In this mode, you also are able to speak with the other party and transmit/receive a document manually when in your office.

The unit automatically distinguishes between voice and fax calls.

- a) If the unit detects a fax tone while playing the greeting message, it will automatically activate the fax function.
- b) If the calling party presses the asterisk (*) key while playing the greeting message or incoming message recording mode, it will automatically activate the fax function.
- c) If the caller's voice is heard within 5 seconds after the beep of the end of the greeting message, the unit will function as an answering device. When the unit does not hear a voice within 5 seconds, the fax function is activated.

TEL/FAX mode:

When in the office, you may select this mode. The unit will automatically distinguish between a telephone call and a fax call.

- a) When the unit receives a fax call, it will automatically activate the fax function and initiate fax reception.
- b) When the unit receives a telephone call, it will ring several times until you pick up the handset. If you do not pick up the handset, the unit will switch automatically to the fax mode.

FAX mode:

When you wish to use the unit as a facsimile machine only, select this mode.

If someone calls you when your unit is in the FAX mode, a fax tone sounds and the person cannot talk to you. Please inform your callers that this is a fax only telephone number.

When in the FAX mode, you may still use the fax telephone to place outgoing voice calls.

TEL (Telephone) mode:

When you wish to use the unit as a standard telephone, select this mode. If you wish to receive an incoming fax during a telephone conversation, press the START button.

Table of Contents

Chapter 1 Installation and Initial Preparation

Location of Controls	1-2
Front view	1-2
Rear view	1-3
Side view	1-3
Buttons and Indicators	1-4
Installing Your Unit	1-7
Accessories	1-7
Installation connections	1-8
Installing the microcassette tape	1-9
Installing the recording paper	1-10
Setting selectors	1-12
Turning the POWER switch on	1-13
Recording Your Greeting Message	1-14
Suggested message	1-14
Recording a greeting message	1-15
Checking your greeting message	1-15
Selecting the RECEIVE MODE	1-16
Setting Up Your Facsimile Unit	1-17
System setup features	1-17
How to set up	1-19
Setting date and time	1-20
Setting your logo	1-22
Programming your facsimile telephone number	1-24
Your fax document identifiers	1-25
Individual transmission report setting	1-26
Selecting the number of rings to answer in the ANS/FAX mode	1-28
Selecting the number of rings to answer in the FAX mode	1-30
Selecting the caller's recording time	1-31
Setting the remote code (REMOTE TAD ID) for remote TAD operation	1-32
HELP Function—If you have lost your procedures—	1-33
Using the HELP button	1-33

Chapter 2 Basic Instructions

Facsimile and Copier

Before Transmitting Documents	2-2
Acceptable documents	2-2
Documents you cannot send	2-2
Resolution and contrast	2-3

Loading documents	2-3
Transmitting Documents	2-4
Manual transmission	2-4
Adding extra pages	2-5
Receiving Documents and/or Voice Calls	2-6
Manual reception	2-6
Automatic reception	2-7
Receiving in the ANS/FAX mode	2-7
Receiving in the TEL/FAX mode	2-8
Receiving in the FAX mode	2-8
Making a Copy	2-9
<i>Answering Device</i>	
Operating as an Answering Device	2-10
Setup of voice message and document reception	2-11
Listening to newly recorded messages	2-11
Listening to all the recorded messages	2-12
Recording after the messages you want to save	2-12
Monitoring incoming calls	2-13
Recording a memo message	2-13
Recording a telephone conversation (2-way recording)	2-14
<i>Telephone</i>	
Making and Answering Voice Calls	2-15
Making voice calls	2-15
Redialing the last dialed number	2-16
Answering voice calls	2-16

Chapter 3 Intermediate Instructions

Storing Phone Numbers for Automatic Dialing	3-2
Listing the directory card	3-2
Storing phone numbers for one touch dialing	3-3
Storing phone numbers for speed dialing	3-4
Storing secret phone numbers	3-5
Erasing a stored phone number	3-6
<i>Facsimile</i>	
Transmitting Documents Using Automatic Dialer	3-7
<i>Telephone</i>	
Making Voice Calls Using Automatic Dialer	3-8

Chapter 4 Advanced Instructions

TONF
T

Installation and Initial
Preparation

Facsimile and Copier

Delayed Transmission

Polling

 Polling another unit manually

 Polling another unit using automatic dialer

 Setting the polling password

Network Communication

 Using a passcode 4-8

 Programming the main passcode 4-9

 Turning the TX passcode check on 4-10

 Turning the RX passcode check on 4-11

Remote Fax Receiving Using an Extension Phone 4-12

 Using an extension phone 4-12

 Programming a remote fax activation code 4-13

Setting the Logo Print Position 4-14

Setting a Customized Header 4-15

Setting the Paper Save Function 4-17

Extension Copy 4-18

Answering Device

Operating an Answering Device from a Remote Phone 4-19

 Summary of remote control functions 4-19

 Playing back newly recorded messages (Memory playback) 4-20

 Playing back all messages 4-20

 Back space and skip forward 4-21

 Recording a marker message 4-21

 Resetting the tape for future messages 4-22

 Skipping the greeting message for incoming message
 recording mode 4-23

 Re-recording a greeting message 4-24

Call with Privacy Ring 4-25

 Programming the PRIVACY RING ID 4-25

 Calling with the privacy ring 4-26

Setting the Message Alert 4-27

Telephone

Voice Contact 4-28

 Initiating voice contact 4-28

 Receiving a request for voice contact 4-28

TONE, RECALL and PAUSE Button Usage	4-29
TONE button (Temporary tone dialing)	4-29
RECALL button	4-29
PAUSE button	4-30
Combination dialing	4-30
Other Features	4-31
Setting Day/Night Mode	4-31
Setting the Silent Fax Recognition Ring	4-33
Setting the Recall Mode	4-34
Resetting the setup features	4-35

Chapter 5 Printing Reports and Lists

Activity Report (JOURNAL Report)	5-2
Setting the JOURNAL AUTO PRINT	5-3
Printing a JOURNAL report manually	5-4
List of Stored Phone Numbers (TELEPHONE NUMBER LIST)	5-5
Printing a TELEPHONE NUMBER LIST	5-6
Basic Feature List	5-7
Advanced Feature List	5-8

Chapter 6 General Information

Troubleshooting	6-2
Error code	6-2
General corrective measures	6-3
Clearing a document jam	6-6
Clearing a recording paper jam	6-7
Maintenance	6-9
Cleaning the microcassette compartment	6-9
Cleaning the document feeder unit	6-10
Cleaning the thermal head	6-10
Printing a test pattern	6-11
Display Indications	6-12
Accessory Order Information	6-13
Specifications	6-13
Index	6-14

Chapter 1

Installation and Initial Preparation

Table of contents

Location of Controls	1-2
Front view	1-2
Rear view	1-3
Side view	1-3
Buttons and Indicators	1-4
Installing Your Unit	1-7
Accessories	1-7
Installation connections	1-8
Installing the microcassette tape	1-9
Installing the recording paper	1-10
Setting selectors	1-12
Turning the POWER switch on	1-13
Recording Your Greeting Message	1-14
Suggested message	1-14
Recording a greeting message	1-15
Checking your greeting message	1-15
Selecting the RECEIVE MODE	1-16
Setting Up Your Facsimile Unit	1-17
System setup features	1-17
How to set up	1-19
Setting date and time	1-20
Setting your logo	1-22
Programming your facsimile telephone number	1-24
Your fax document identifiers	1-25
Individual transmission report setting	1-26
Selecting the number of rings to answer in the ANS/FAX mode	1-28
Selecting the number of rings to answer in the FAX mode	1-30
Selecting the caller's recording time	1-31
Setting the remote code (REMOTE TAD ID) for remote TAD operation	1-32
HELP Function	
—If you have lost your procedures—	1-33
Using the HELP button	1-33

When the display shows "E-XX", see page 6-2 for corrective measures.

Location of Controls

Front view

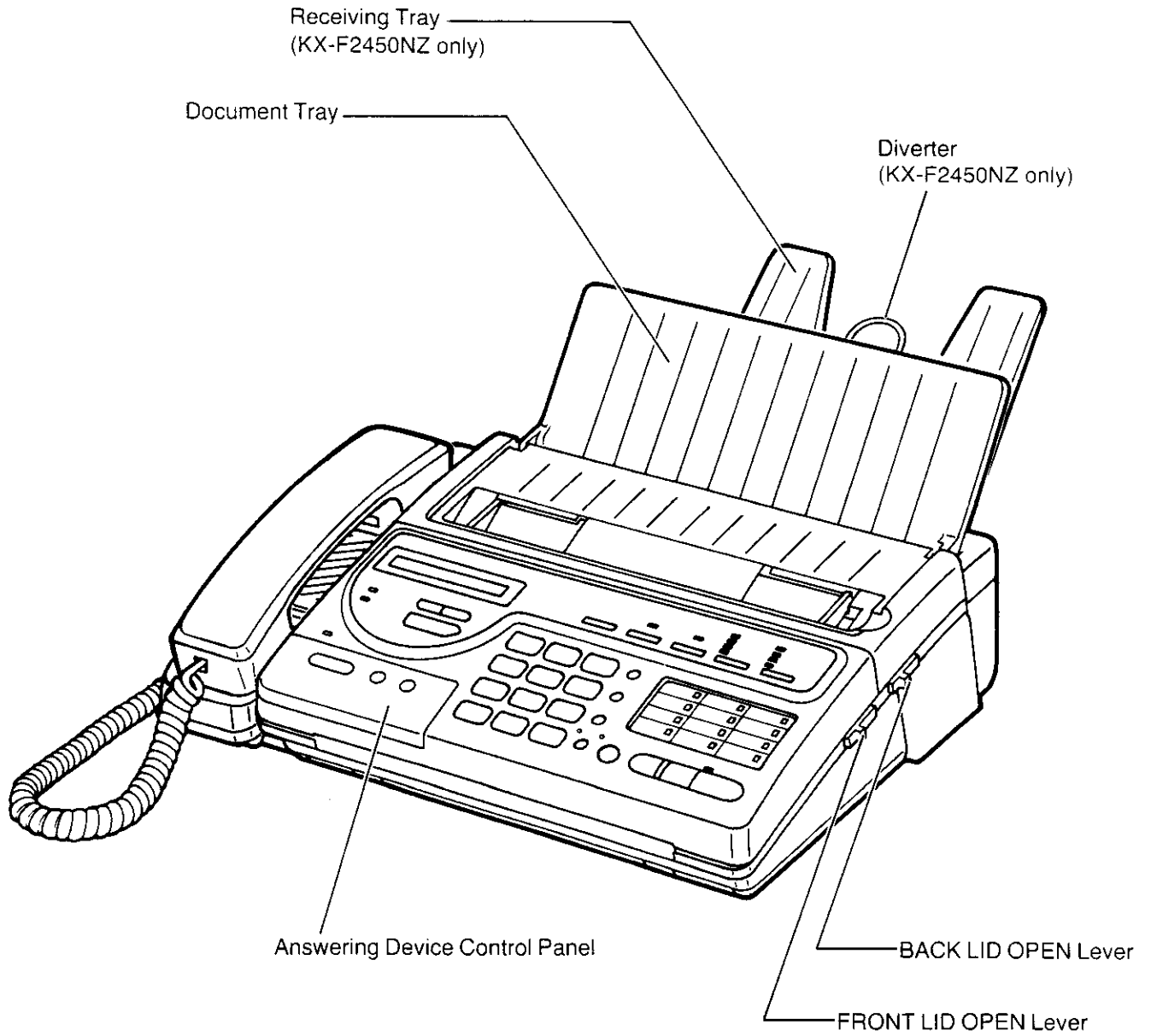

Rear view

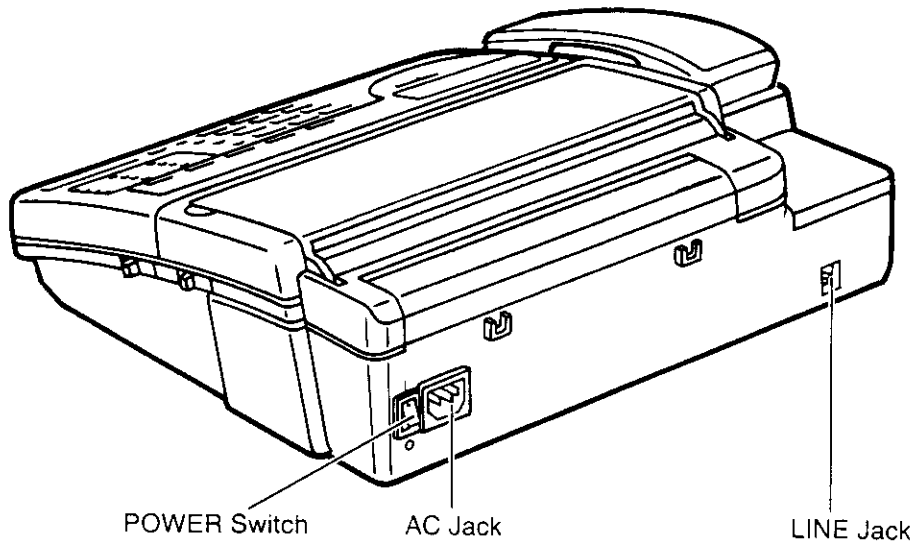

Side view

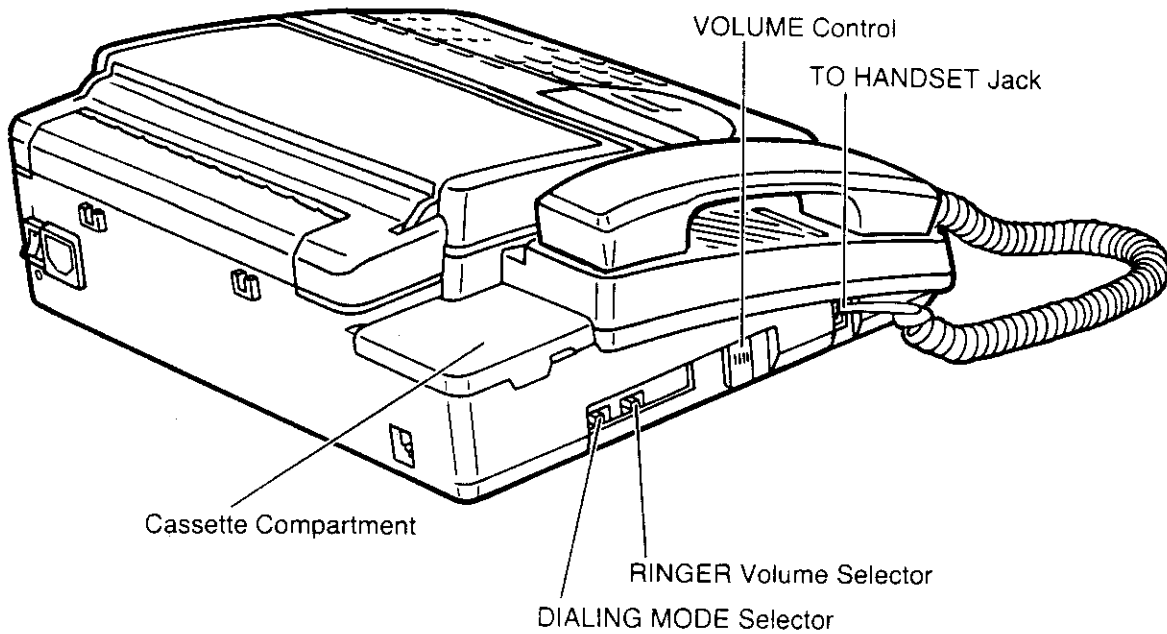

Buttons and Indicators

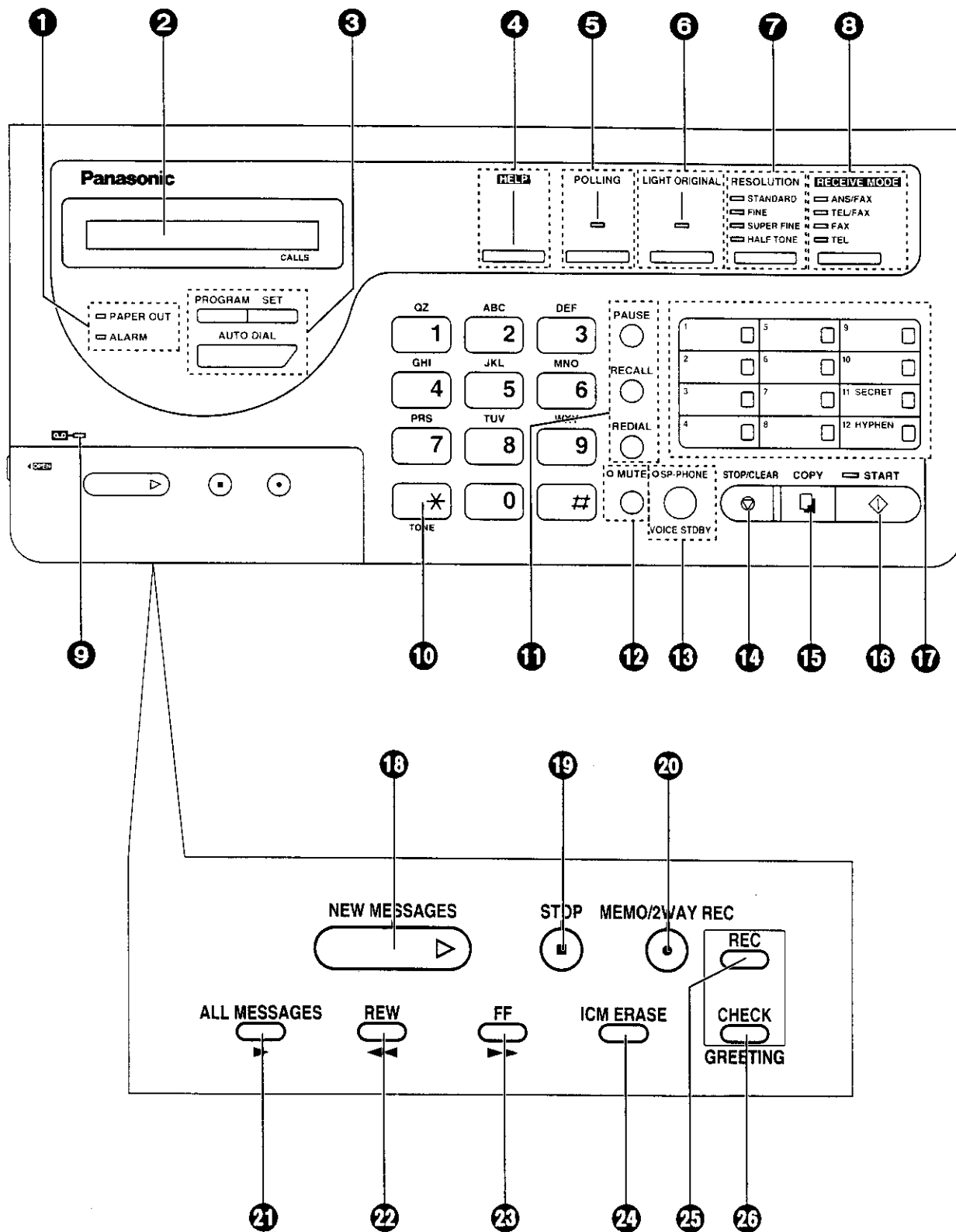

- ❶ PAPER OUT Indicator:**
Page 1-11

The indicator lights when the recording paper roll is empty.

- ALARM Indicator:**
Page 1-13

The indicator lights when any trouble occurs.

- ❷ LCD (Liquid Crystal Display)**

- ❸ PROGRAM Button:**
Page 1-19

Used to start or end programming functions.

- SET Button:**
Page 1-19

Used to store parameters during programming.

- AUTO DIAL Button:**
Pages 3-4 to 3-8

Used for speed dialing.

- ❹ HELP Button:**
Page 1-33

Used to print an easy guide of programming procedures.

- ❺ POLLING Button and Indicator:**
Page 4-4

Used for polling function. The indicator lights when this feature is on.

- ❻ LIGHT ORIGINAL Button and Indicator:**
Page 2-3

Used to transmit or copy originals with faint writing. The indicator lights when this feature is on.

- ❼ RESOLUTION Button and Indicators:**
Page 2-3

Used to adjust scanning line density. The indicators light to show which setting you are using.

- ❽ RECEIVE MODE Button and Indicators:**
Pages 1-16 and 2-7

Used to select the desired receiving mode. The indicators light to show the mode in which the unit is set.

- ❾  Indicator:**
Page 2-10

The indicator flashes when any new incoming messages have been recorded.

- ❿ TONE Button:**
Page 4-29

Used to change the dialing mode from pulse to tone during a dialing operation.

- ⓫ PAUSE Button:**
Page 4-30

Used to insert a pause into a phone number during programming.

- RECALL Button:**
Page 4-29

Used to access some features of your host PBX.

- REDIAL Button:**
Page 2-16

Used to redial the last dialed number.

- ⓬ MUTE Button and Indicator:**

Used when you do not want your voice to be heard by the other party. The voice of the calling party will still be heard. The indicator lights when this feature is on.

- ⓭ SP-PHONE (VOICE STDBY) Button and Indicator:**
Pages 2-4, 2-15 and 4-28

Used for on-hook dialing and voice contact features. The indicator lights when these functions are on.

- 14 STOP/CLEAR Button:**
Pages 1-19, 2-5 and 2-6
Used to cancel transmission or copying operation. Also used during programming to clear the previously entered parameters.
- 15 COPY Button:**
Page 2-9
Used to start copy functions.
- 16 START Button and Indicator:**
Pages 1-19 and 2-4
Used to start transmission or print lists and reports. The indicator lights when these functions are on.
- 17 Direct Call Station Keys:**
Pages 3-2, 3-3 and 3-7
Used for one touch dialing.
- 18 NEW MESSAGES Button:**
Page 2-11
Used to play back only new messages.
- 19 STOP Button:**
Page 2-10
Used to stop operations of answering device.
- 20 MEMO/2WAY REC Button:**
Pages 2-13 and 2-14
Used to start and stop recording of a memo message or a telephone conversation.
- 21 ALL MESSAGES Button:**
Page 2-12
Used to play back all the recorded messages.
- 22 REW (Rewind) Button:**
Pages 2-10 and 2-11
Used to run the tape quickly backward to a desired point.
- 23 FF (Fast Forward) Button:**
Page 2-10
Used to run the tape quickly forward to a desired point.
- 24 ICM ERASE Button:**
Page 2-10
Used to erase recorded incoming messages at high speed.
- 25 REC Button:**
Page 1-15
Used to start and stop recording of a greeting message.
- 26 CHECK Button:**
Page 1-15
Used to replay your greeting message.

Installing Your Unit

Accessories

1. Carefully remove the unit from the packing carton.
2. Examine the unit for signs of shipping damage.
3. Check that all of the enclosures are included. If you are missing any item, consult your place of purchase.

Telephone Line Cord 1 AC Power Cord 1

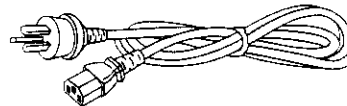
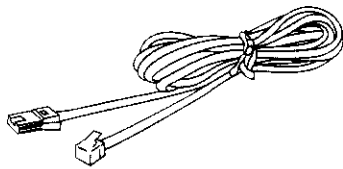

Microcassette Tape 1 Recording Paper 1

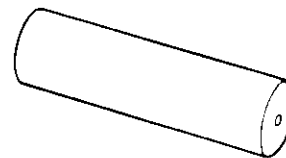
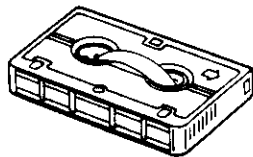

Handset 1 Handset Cord 1

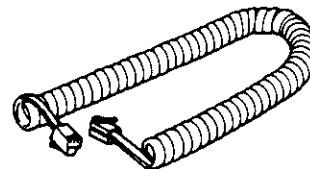
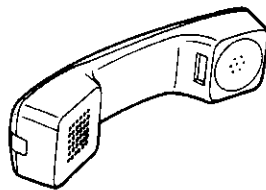

Paper Roll Holders (Green) 2 Receiving Tray 1
 (For KX-A101, or 1/2 inch core) (For KX-F2450NZ only)

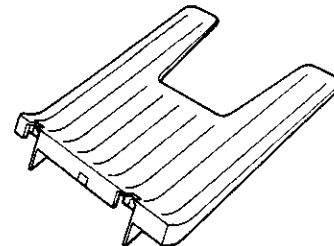
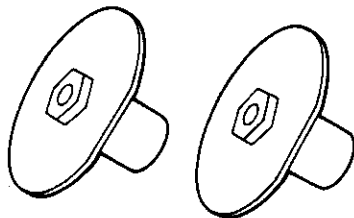

Diverter 1
 (For KX-F2450NZ only)

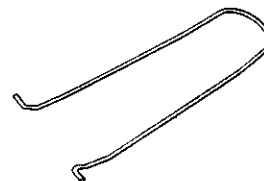

Installation connections

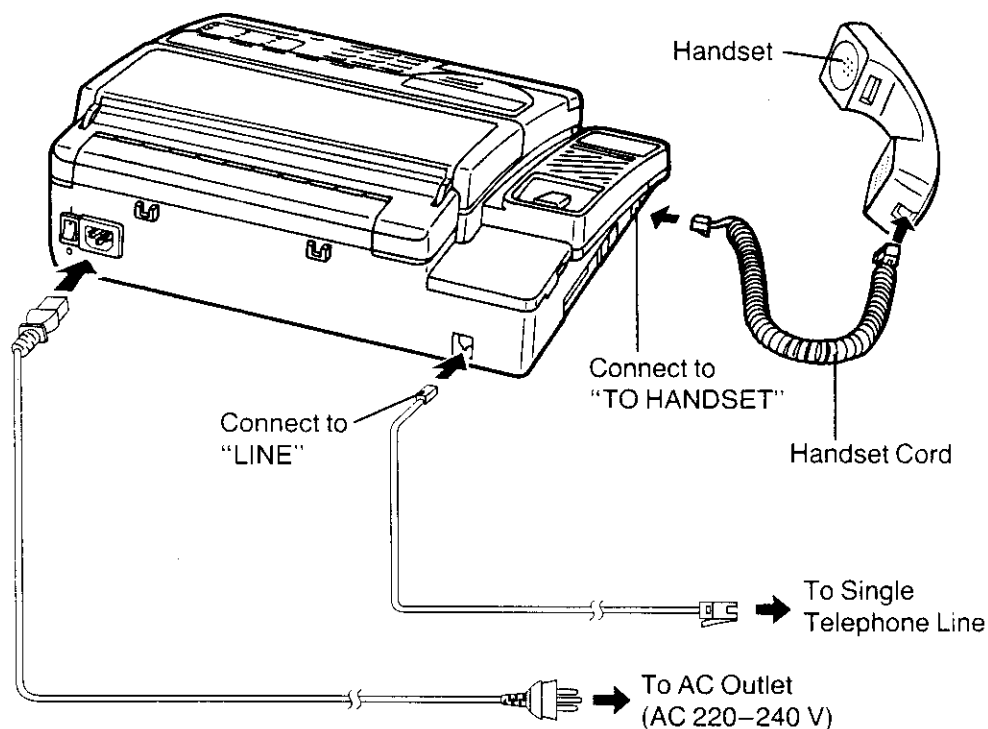

Installing the receiving tray and the diverter (for KX-F2450NZ only)

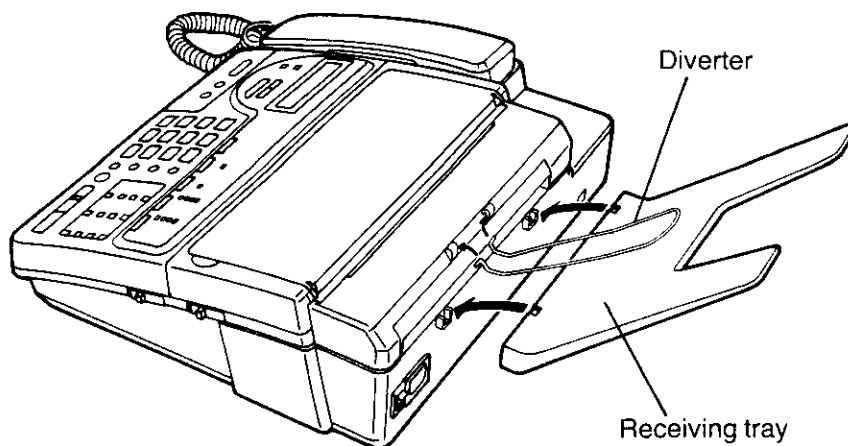

NOTES:

- The unit will not function during a power failure or when the power is turned off.
- Connection to integrated answering machines is not recommended.
- This unit is equipped with a 3-wire grounded type plug for safety. If you are unable to insert the plug into your outlet, contact your electrician to replace your outlet.
- We recommend the use of an exclusive AC outlet to avoid interference from other equipment.
- If your unit is connected to the same line as other extensions, do not use other extensions during fax transmission and reception. Image quality will be affected.

Installing the microcassette tape

The microcassette tape is used to record incoming messages.
To install a microcassette tape:

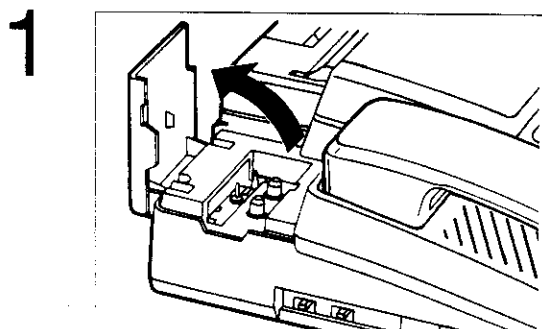

Pull up the cassette compartment cover.

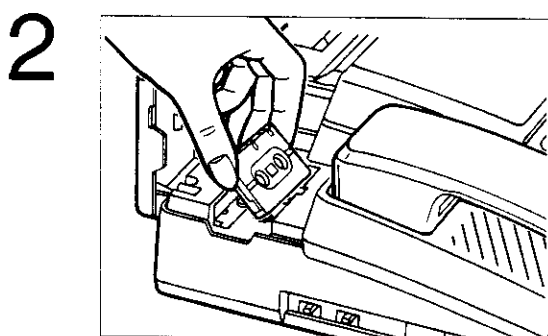

Insert the microcassette tape into the compartment with the full reel to the left. Make sure that there is no slack in the tape. Remove any slack by using a pencil and rotating the tape reel.

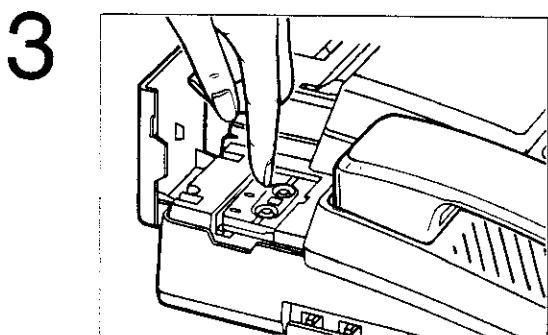
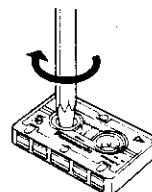

Push the microcassette tape down. Then close the cassette compartment cover.

To take off the microcassette tape:

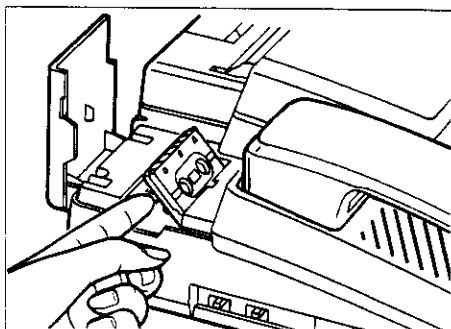

Lift the microcassette tape as shown, then take it off.

NOTES:

- For optimum sound quality and performance, use the opposite side (side B) after six months and replace the tape with a new one every year, assuming that the unit answers about ten calls a day.
- Never place a cassette tape near a magnetic source such as a magnet or a TV set because it may erase or interfere with any messages on the tape.
- Should the cassette tape break or become worn, replace it with a new one. We recommend using the Panasonic cassette tape **MC-30** or **MC-60**.

Installing the recording paper

To install a new roll of recording paper:

1

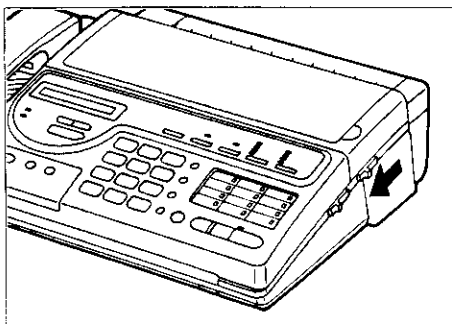

Slide the BACK LID OPEN lever forward to open the paper compartment cover.

2

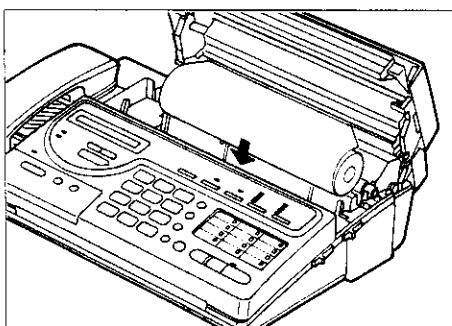

Place a recording paper roll into the paper compartment.

Make sure that the shiny side of the paper is facing up and that there is no slack in the paper roll.

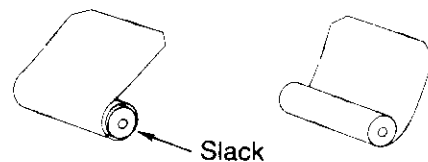

Instructions for KX-F2350NZ users:

3^a

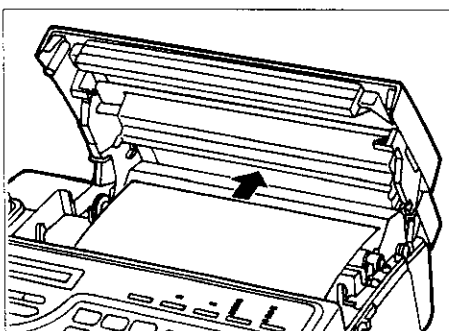

Insert the leading edge of recording paper into the recording paper exit.

Then pull the paper a few centimeters (one or two inches) out of the unit.

4^a



Close the paper compartment cover carefully by pressing down on both ends gently.

Instructions for KX-F2450NZ users:

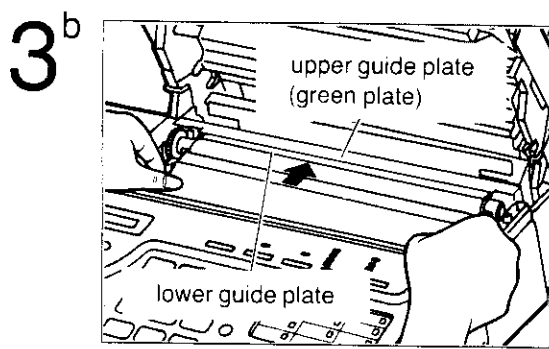

Insert the leading edge of recording paper between the upper guide plate (green plate) and the lower guide plate. Then pull the paper a few centimeters out of the unit.

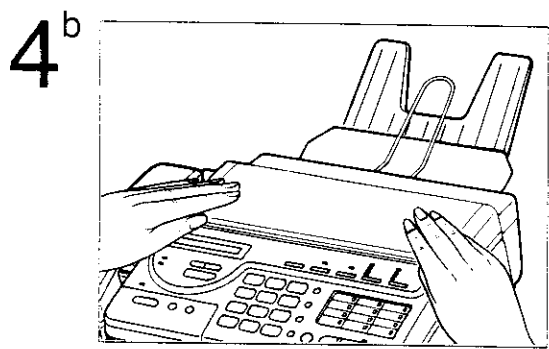

Close the paper compartment cover carefully by pressing down on both ends gently.

When the unit is on, the recording paper will project itself slightly and be cut automatically.

NOTES:

- Use only the included roll or specified recording papers (Part No. KX-A101 and KX-A106) for supplement or else the print quality may be affected or excessive thermal head wear may occur.
- To install the KX-A101 or a recording paper with 1/2 inch core, you should use the included paper roll holders for paper curl reduction system as shown below.

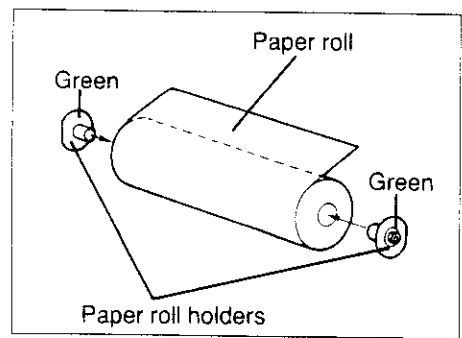

Fix the paper roll holders on both sides of the recording paper roll.

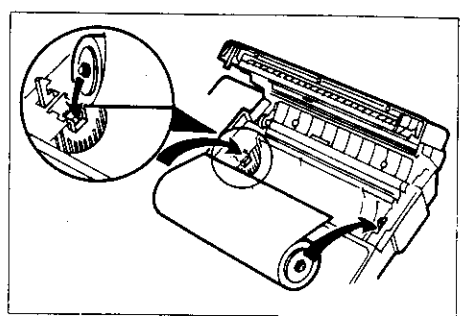

Insert the left projection of the paper roll holder into the left groove on the unit then the right projection into the right groove, while pushing the paper roll to the left.

Follow the procedures from Steps 3 to 4 to finish installing a KX-A101 or a recording paper with 1/2 inch core.

- If the recording paper is heavily curled, the paper curl reduction system may not function properly.
- Replace the paper roll with a new one:
 - when the red lines appear on both sides of the recording paper.
 - when the PAPER OUT indicator lights.
 - when the display shows "E-06".

Setting selectors

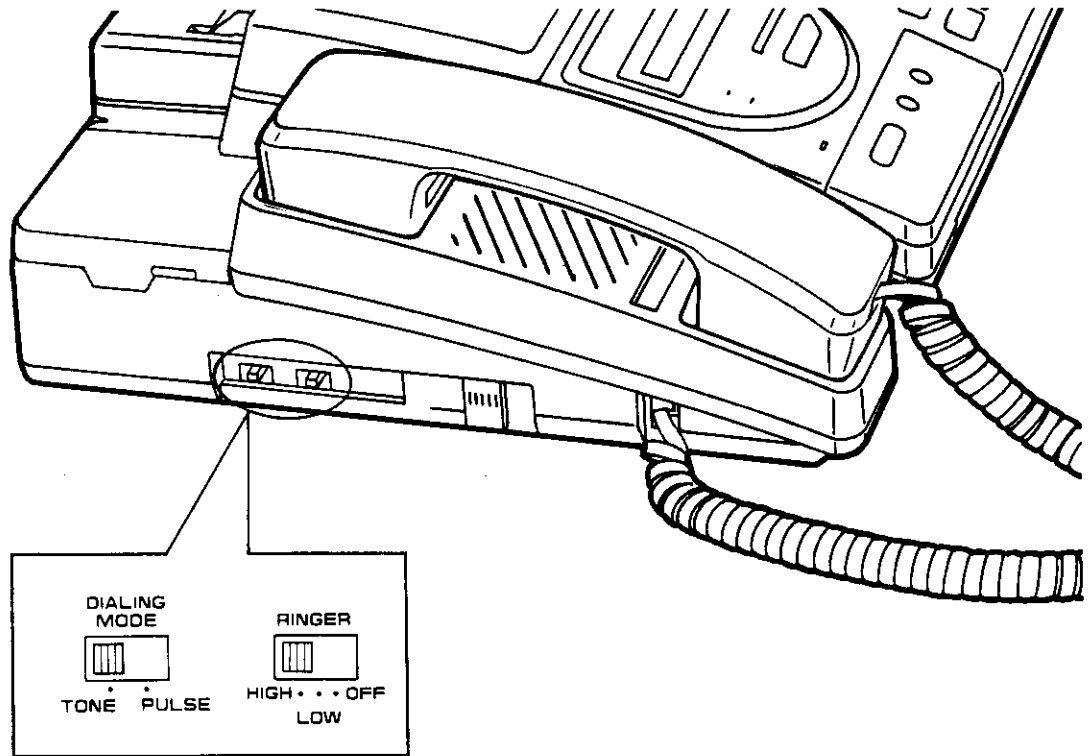

DIALING MODE Selector:

If your line has,

1. Touch tone service, set the selector to **TONE**.
2. Rotary pulse dial service, set the selector to **PULSE**.

RINGER Volume Selector:

HIGH: The ringing sound will be loud.

LOW: The ringing sound will be soft.

OFF: The unit will not ring.

Turning the POWER switch on

Before turning the POWER switch on, confirm the following:

- All connections are completed.
- The cassette tape and the recording paper are installed properly.
- The handset is on the cradle.

1. Turn the **POWER** switch to the "I" (ON) position.

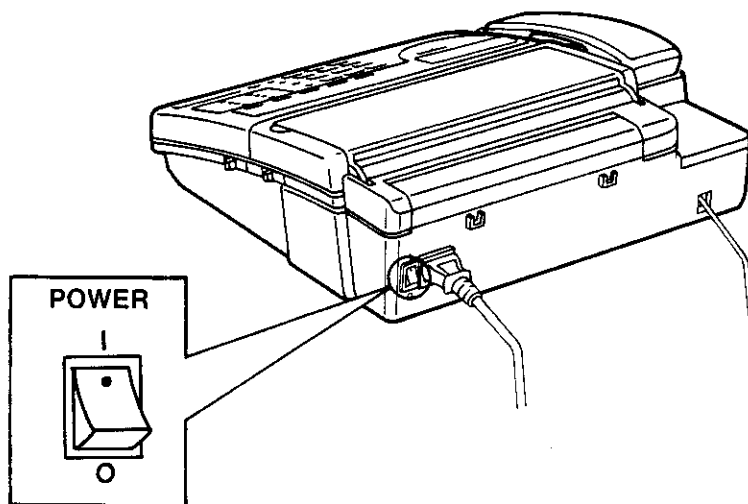

2. When you turn on the unit for the first time, the error code "E-30" will be displayed. This shows that the greeting message is not recorded. To record your greeting message, see pages 1-14 and 1-15. If the greeting message is not recorded, you cannot use the unit properly as both an answering device and a facsimile.

NOTES:

- If the ALARM indicator lights when you turn the POWER switch on, confirm that the covers are closed firmly.
- If the PAPER OUT indicator lights, install the recording paper properly. See pages 1-10 and 1-11.

Recording Your Greeting Message

Record a greeting message before using your machine as an answering machine and facsimile.

The greeting message tells the caller that you are unable to answer, and allows him or her to leave a voice-message or to send a fax message.

You can store a greeting message up to 16 seconds.

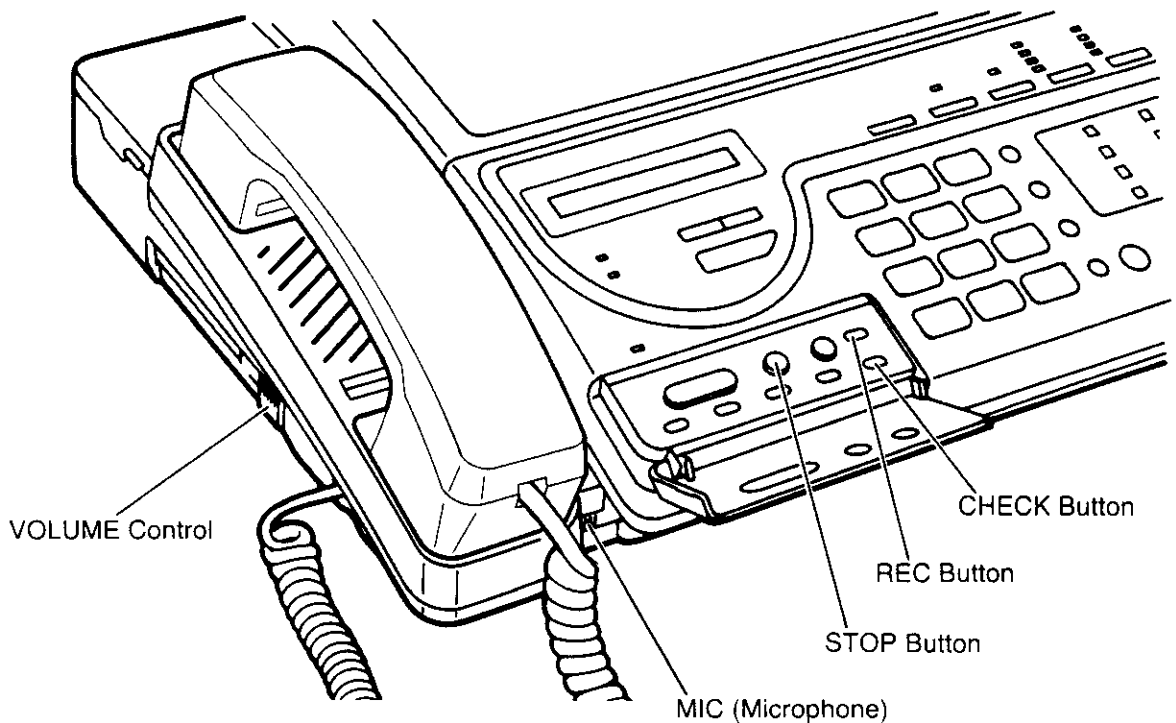

Suggested message

Record your greeting message referring to the examples below.

—When the incoming message recording time is unlimited:

"This is (your name, business and/or telephone number). We are unable to answer right now. To send a fax, start transmission. To leave a message, speak after the long beep. Thank you."

—When the incoming message recording time is limited to 1 minute:

*"This is (your name, business and/or telephone number). We are unable to answer right now. To send a fax, start transmission. To leave a message, speak for **up to 1 minute** after the long beep. Thank you."*

You can choose from two lengths of recording times for incoming messages. When the unit is in the "VOX" position, the recording time is unlimited, and when in the "1MIN" position, the recording time is limited to 1 minute. The two examples above correspond to these two conditions. The unit is preset to the "VOX" position. To change the recording time, see page 1-31.

Recording a greeting message

Recording time is limited to 16 seconds. Record your greeting message within 12 seconds for optimum performance.

1

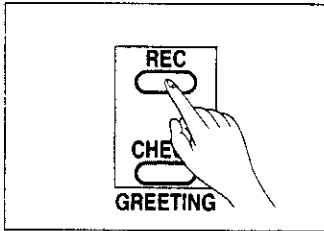

Press the **REC** button.

A beep is heard.

2

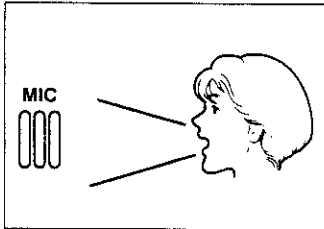

After the beep, speak immediately, clearly and loudly toward the microphone from a distance of approximately 20 cm.

3

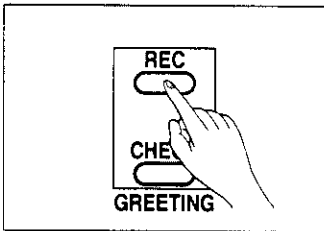

When finished, press the **REC** button again or the **STOP** button.

4

The unit plays back your greeting message so that you can confirm it.
Adjust the **VOLUME** control to a suitable level.

NOTE:

If you make a mistake while recording, repeat from Step 1.

Checking your greeting message

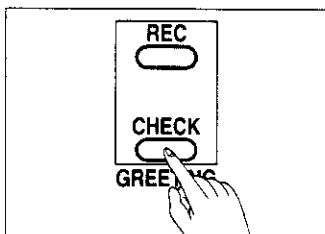

Press the **CHECK** button.

The unit replays your greeting message. If you want to change your message, perform the operation on this page again. The previous message will be automatically erased and a new message will be recorded.

Selecting the RECEIVE MODE

The unit has four types of receiving modes:

- ANS/FAX mode** —When you want to use as a telephone answering device (TAD) and a facsimile, or when the machine is unattended.
- TEL/FAX mode** —When you want to use telephone and facsimile.
- FAX mode** —When you want to use facsimile only.
- TEL mode** —When you want to use as a standard telephone only.

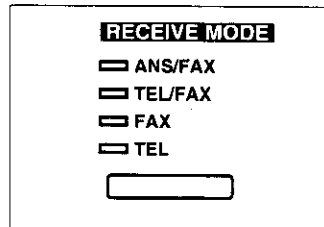

Press the **RECEIVE MODE** button to select the desired receiving mode.

HELPFUL HINTS:

■ **When you are out of office—ANS/FAX mode:**

The unit will automatically distinguish between a voice and a fax call.

If a fax tone is heard, the unit will switch automatically to fax. If the caller's voice is heard within 5 seconds of the beep at the end of the greeting message, the answering device will receive messages.

You are also able to speak with the other party and transmit or receive documents when in this mode.

■ **When you are in the office—TEL/FAX mode:**

The unit will automatically distinguish between a normal telephone call and a fax call.

When the unit receives an automatic fax transmission call, it will switch automatically to fax and initiate fax reception.

When the unit receives a voice or manual transmission call, it will ring several times until you pick up the handset.

—If you do not pick up the handset, the unit will automatically activate the fax function.

—When you pick up the handset and nothing is heard, manual fax reception is required. Press the **START** button and hang up to receive the fax.

■ **When you wish to use as a facsimile only—FAX mode:**

In this mode you will only be able to receive fax calls. Incoming voice calls will hear the fax tone. You are still able to make outgoing voice calls.

■ **When you wish to use as a standard telephone—TEL mode:**

This mode is for use as a standard telephone. You can also receive a fax during a telephone conversation by pressing the **START** button.

In this mode, if you do not answer the call until the unit rings 15 times, the unit will automatically switch to the ANS/FAX mode.

Setting Up Your Facsimile Unit

System setup features

The unit has 9 Basic Features, as listed below, and 20 Advanced Features, as listed on page 1-18.

Basic Features are the settings that need to be programmed upon finishing the installation. Most probable choices have been preselected for you, but some features, such as SET DATE, YOUR LOGO and YOUR TELEPHONE NUMBER, must be programmed by the user.

Advanced Features should be temporarily programmed as the need arises.

BASIC FEATURE LIST

The bold-face indicates factory default settings.

Code	Functions	Descriptions	Selections	Pages
#01	SET DATE	Sets the current date and time	(not stored)	1-20 1-21
#02	YOUR LOGO	Sets your company name or personal name	up to 30 digits	1-22 1-23
#03	YOUR TELEPHONE NUMBER	Sets your facsimile telephone number	up to 20 digits	1-24
#04	PRINT TRANSMISSION REPORT	Individual transmission report setting	ON/ERROR/OFF	1-26 1-27
#05	ANS/FAX RING COUNT	Selects the number of rings to answer in the ANS/FAX mode, or sets RINGER to off	TOLL SAVER or 2 to 4 rings or RINGER OFF	1-28 1-29
#06	FAX RING COUNT	Selects the number of rings to answer in the FAX mode	2 to 4 rings	1-30
#07	RECORDING TIME FOR TAD	Selects the recording time for incoming message	VOX (unlimited) or 1MIN (1 minute)	1-31
#08	REMOTE TAD ID	Sets the remote control code for remote TAD operation	3 digits (111)	1-32
#99	PRINT ADVANCED FEATURE LIST	Prints the advanced feature list		5-8

ADVANCED FEATURE LIST

The bold-face indicates factory default settings.

Code	Functions	Descriptions	Selections	Pages
#10	LOGO POSITION	Sets the LOGO print position on the transmitted document	OUT/IN/OFF	4-14
#11	JOURNAL AUTO PRINT	Prints out the journal report automatically or manually	AUTO/MANUAL	5-3
#12	MAIN PASSCODE	Sets the passcode for network communication	4 digits (0000)	4-9
#13	TX PASSCODE CHECK	Turns the transmission passcode check mode on	ON/OFF	4-10
#14	RX PASSCODE CHECK	Turns the reception passcode check mode on	ON/OFF	4-11
#15	POLLING PASSWORD	Sets the password for polling	4 digits (0000)	4-6
#16	DELAYED TRANSMISSION	Sets the delayed transmission feature	ON/OFF	4-2 4-3
#17	PRIVACY RING ID	Sets the PRIVACY RING ID	3 digits (333)	4-25
#18	DAY/NIGHT MODE	Turns on the Day/Night Mode	ON/OFF	4-31 4-32
#19	SILENT FAX RECOGNITION RING	Sets the silent fax recognition ring	3 to 8 rings	4-33
#20	REMOTE FAX ACTIVATION CODE	Sets the remote fax activation code	2 to 4 digits (**)	4-13
#21	PAPER SAVE FUNCTION	Turns on the paper save function	ON/OFF	4-17
#22	MESSAGE ALERT	Turns on the message alert	ON/OFF	4-27
#23	CUSTOMIZED HEADER	Sets a customized header	A/B/C/OFF	4-15 4-16
#24	EXTENSION COPY	Copies a document twice in length		4-18
#26	PRINT JOURNAL	Prints a JOURNAL report		5-4
#27	PRINT TEL LIST	Prints a telephone number list		5-5 5-6
#28	PRINTER TEST	Prints a print test pattern		6-11
#30	RECALL MODE	Sets the recall mode	T_BR/E_RE	4-34
#50	SET DEFAULT (#10 TO #30)	Resets the setup features		4-35

How to set up

To set up your unit, proceed as follows.

1. Press the **PROGRAM** button.
The display shows "P- ".
2. Press #, then enter the code number you wish to set using the dial keypad.
Refer to the lists on pages 1-17 and 1-18.
3. Enter desired choice or data.
4. If you entered "#26", "#27", "#28", "#50" and "#99", press the **START** button.
If you entered "#24", press the **COPY** button.
Otherwise press the **SET** button to store your selection.
5. Press the **PROGRAM** button to end the operation.

NOTES:

- When you lose your procedures while programming, press the HELP button. You will be able to print information about how to set up. See pages 1-33 and 1-34.
- To correct an error while programming, press the STOP/CLEAR button then correct input.
- To cancel programming on the way, press the PROGRAM button. The display shows the current time.

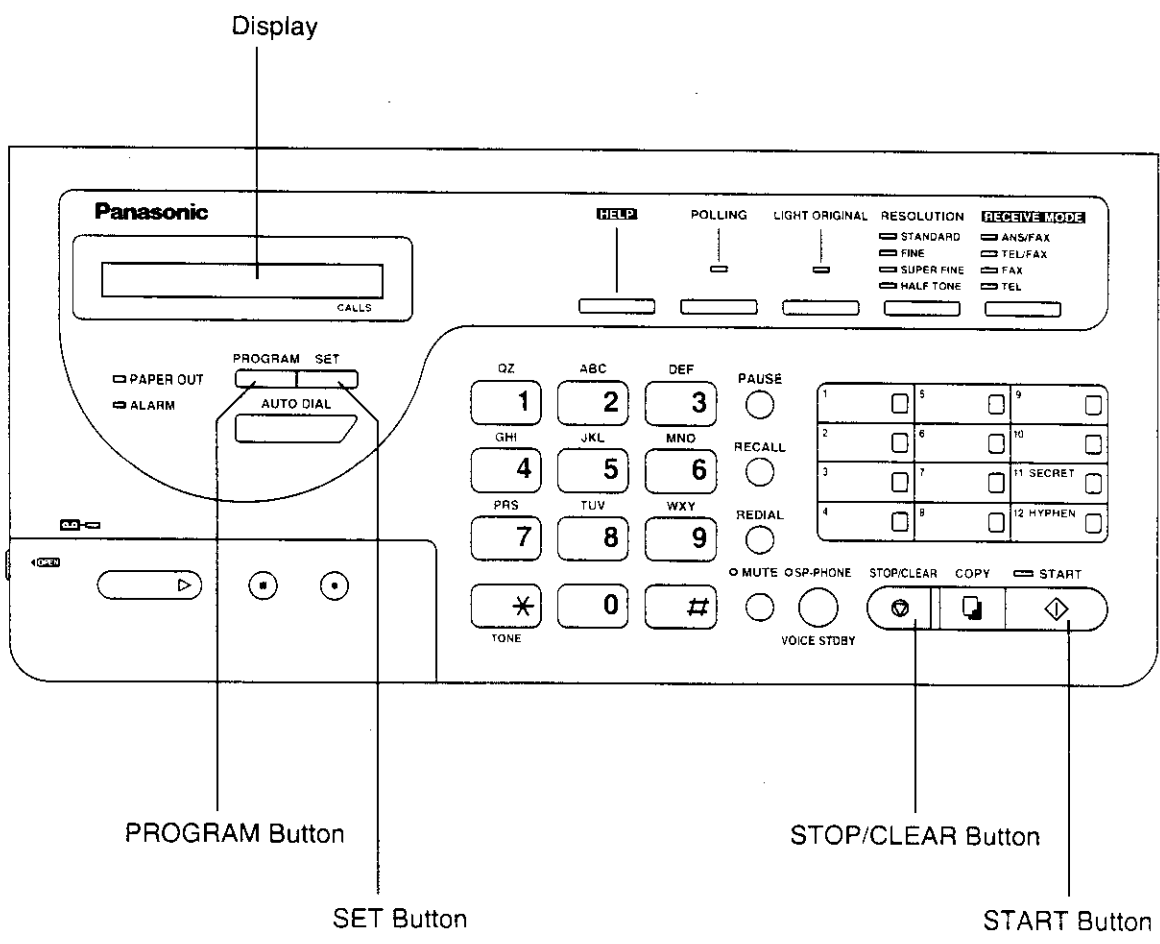

Setting date and time

The internal clock of the unit will print the date and time on the top line of all fax messages you transmit.

When the unit is in idle status, the display shows the current time and the number of recorded incoming messages. "Month/day/year" are not displayed. These settings appear on the top line of all the documents you transmit and the fax communication reports such as JOURNAL report and transmission report.

1

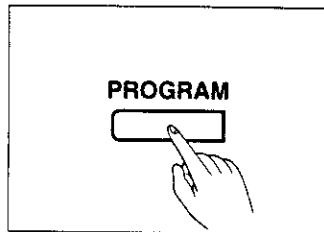

Press the **PROGRAM** button.

The display shows "P- ".

2

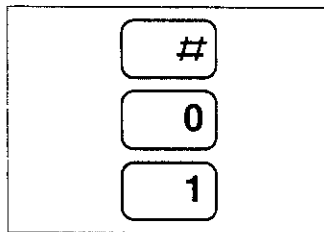

Press #, then press 01 for SET DATE setting.

The display shows "P-F01 01-01 1993".

3

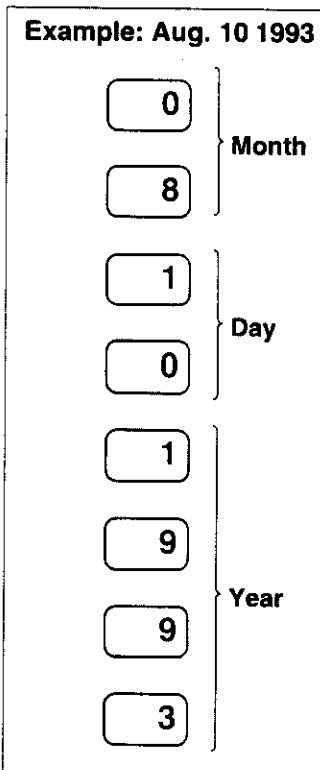

Enter current month/day/year by using the dial keypad.

Example: Aug. 10 1993.

Press 08, 10, then press 1993.

4

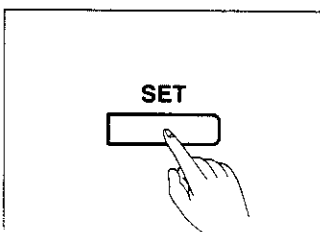

Press the **SET** button.

The display will show the previously assigned time.

(continued)

5

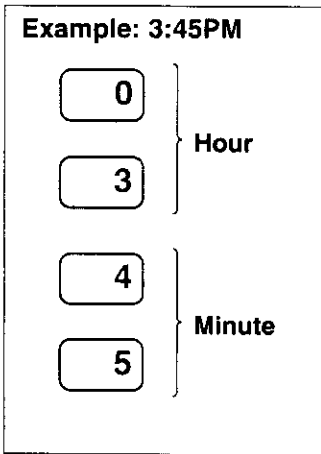

Enter the current time by using the dial keypad.

Example: 3:45 PM

Press 03, then press 45.

PM or AM is alternately selected by pressing *.

6

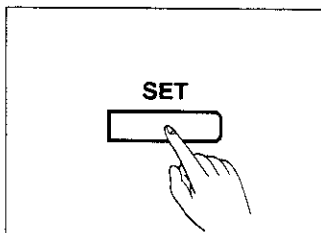

Press the **SET** button to store the program into memory.

The display shows "P- ".

7

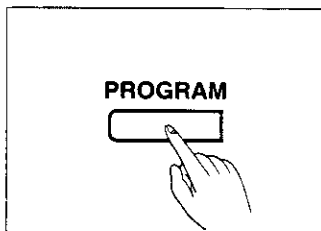

Press the **PROGRAM** button to end the operation.

The display shows the stored time.

NOTE:

To correct an error while programming, press the STOP/CLEAR button then correct input.

Setting your logo

The logo is used to identify fax documents sent by your unit. It may consist of alphanumeric letters and symbols.

Usually the logo is a company, division or personal name in an abbreviated form. Your programmed logo will be printed on the top of each page transmitted from your unit.

Your printed logo can be up to 30 digits long.

To enter each character, select the correct code (2 digits) referring to the character code table (see page 1-23), then program as follows.

1

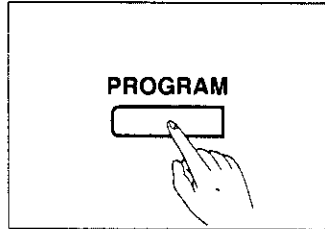

Press the **PROGRAM** button.

The display shows "P- ".

2

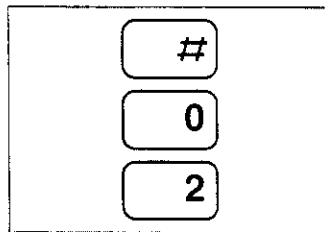

Press #, then press **02**.

The display shows "P-F02 45 60 73".

To obtain the character codes, press the **HELP** button.

3

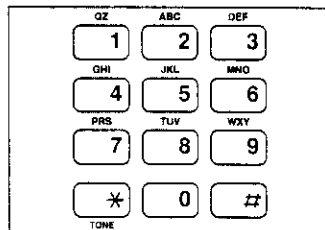

Enter your logo by using the dial keypad.

The logo can be up to 30 characters long.

If you wish to check your programming, press the **HELP** button.

4

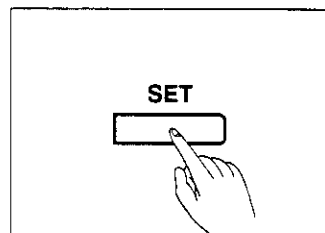

When finished, press the **SET** button to store the program into memory.

The display shows "P- ".

5

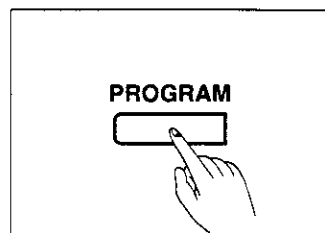

Press the **PROGRAM** button to end the operation.

The display shows the current time.

Character Code Table

Input	Code	Input	Code	Input	Code	Input	Code	Input	Code
(*1)	00)	10	0	20	A	30	K	40
(Space)	01	*	11	1	21	B	31	L	41
!	02	+	12	2	22	C	32	M	42
"	03	,	13	3	23	D	33	N	43
#	04	-	14	4	24	E	34	O	44
\$	05	.	15	5	25	F	35	P	45
%	06	/	16	6	26	G	36	Q	46
&	07	:	17	7	27	H	37	R	47
'	08	:	18	8	28	I	38	S	48
(09	<	19	9	29	J	39	T	49
Input	Code	Input	Code	Input	Code	Input	Code	Input	Code
U	50	a	60	k	70	u	80	_	90
V	51	b	61	l	71	v	81	`	91
W	52	c	62	m	72	w	82	{	92
X	53	d	63	n	73	x	83	,	93
Y	54	e	64	o	74	y	84	}	94
Z	55	f	65	p	75	z	85	→	95
=	56	g	66	q	76	[86	(*2)	96
>	57	h	67	r	77	¥	87		
?	58	i	68	s	78]	88		
@	59	j	69	t	79	^	89		

*1: Enter "00" to erase all of the characters that have been programmed (all clear).
 *2: Enter "96" to delete the last character (back space).

■ Check your logo and codes referring to the character code table before programming.

Example: If the logo is ABC Company, fill out the form as follows.

	5					10						15			
Input	A	B	C		C	o	m	p	a	n	y				
Code	30	31	32	01	32	74	72	75	60	73	84				

Write your own logo and its code in the form below.

	5					10						15			
Input															
Code															
Input															
Code															
	20					25						30			

Programming your facsimile telephone number

Your facsimile telephone number can be programmed into your unit.

When you transmit a document, your programmed number will be printed on the top of each page transmitted from your unit.

The unit can hold your phone number up to 20 digits long.

1

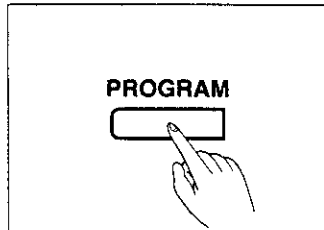

Press the **PROGRAM** button.

The display shows "P- ".

2

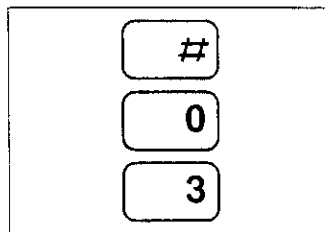

Press #, then press **03**.

The display shows "P-F03 ".

3

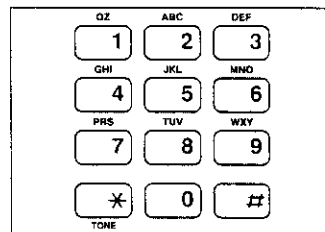

Enter your telephone number by using the dial keypad up to 20 digits long.

Example: If the phone number is +123 4567, press *, 123, #, then press 4567.

The display shows; "P-F03 123 4567"

4

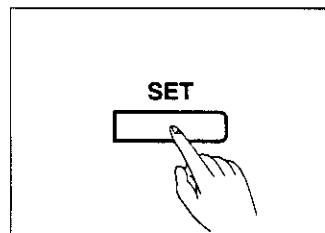

When finished, press the **SET** button to store the program into memory.

The display shows "P- ".

5

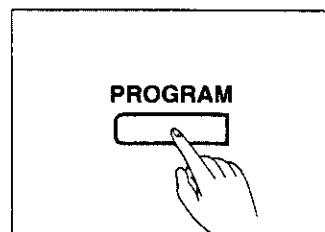

Press the **PROGRAM** button to end the operation.

The display shows the current time.

NOTES:

- When you press * in Step 3, the display shows "4", but "4" will be replaced by "+" on the print-out.
- The # button provides a space.

Your fax document identifiers

Your programmed logo and telephone number will be printed on the top of each page transmitted from your unit, along with the date, time and page number. This gives the receiving party your name and fax telephone number if they wish to return a fax.

Sample pages sent by your unit

YOUR LOGO	YOUR TELEPHONE NUMBER	DATE & TIME	Number of page
FROM : ABC Company	PHONE NO. : +123 4567	Jan. 01 1997 03:05AM	P01
FAX CORRESPONDENCE			
TO: _____		DATE: _____	
FROM: _____		OUR TEL. NO.: _____	

Individual transmission report setting

Each time a document is transmitted, this feature gives you a printed record of the transmission (XMT REPORT).

The following choices are available;

ON: The report is printed, indicating whether the transmission is successful or not.

ERROR: The report is printed only when transmission fails (default).

OFF: The report is not printed.

Sample of the transmission report:

Print time: Hour/Minute AM/PM
Print date: Month/Day/Year

```
***** XMT REPORT *****  
+  
+  
+ Jan. 01 1992 11:30AM  
+-----+-----+-----+-----+-----+-----+-----+-----+  
* NO.   OTHER FACSIMILE   START TIME  USAGE TIME  MODE  PAGES  RESULT  CODE  
+-----+-----+-----+-----+-----+-----+-----+-----+  
* 01     1234567          Jan. 1 11:29AM  01'08  TX     02     OK       (00)  
+-----+-----+-----+-----+-----+-----+-----+-----+  
+  
+  
+  
+  
+-----+-----+-----+-----+-----+-----+-----+-----+  
*****
```

Labels for the sample report:

- 01:** Communication number
- 1234567:** Dialed number or other party's name
- Jan. 1 11:29AM:** Communication start time
- 01'08:** Length of communication: Minutes/Seconds
- TX:** Transaction mode: TX...Transmission
- 02:** Number of pages transmitted successfully
- OK:** Communication result
- (00):** Error code (for the service center only)

Explanation of communication result

OK:	Successful communication
PRESSED THE STOP KEY:	The fax communication was interrupted since the STOP/CLEAR button was pressed.
DOCUMENT JAMMED:	A document jammed.
NO DOCUMENT:	The document was not fed into the unit properly.
PRINTER OVERHEATED:	Printing head was overheated.
PAPER OUT:	The unit is out of recording paper.
THE COVER WAS OPENED:	The front lid or back lid was opened.
COMMUNICATION ERROR:	Transmission or reception error.
PASSCODE FAILED:	Passcode communication failed.
NO RESPONSE:	Receiving unit is busy or out of recording paper.
PAPER JAMMED:	The recording paper was jammed.

To change the individual transmission report setting, proceed as follows.

1

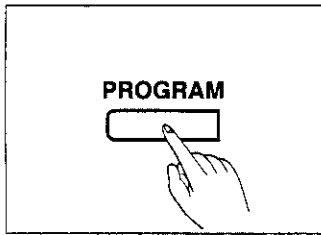

Press the **PROGRAM** button.

The display shows "P- ".

2

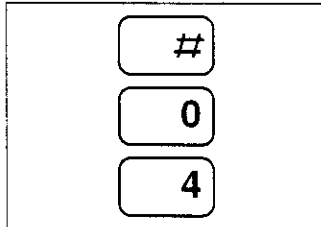

Press #, then press **04**.

The display shows "P-F04 2".

3

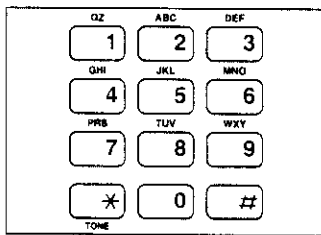

Press the number of the mode you desire.

Setting selections are:

- 1: ON
- 2: ERROR
- 3: OFF

4

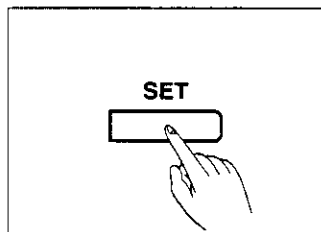

Press the **SET** button to store your selection into memory.

The display shows "P- ".

5

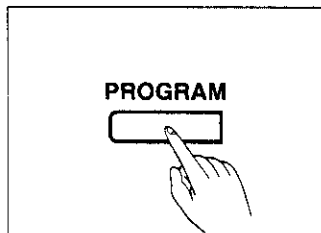

Press the **PROGRAM** button to end the operation.

The display shows the current time.

Selecting the number of rings to answer in the ANS/FAX mode

When in the ANS/FAX mode, the unit will automatically answer on the second ring when receiving call.

If you wish to change the number of rings to answer a call, you can choose among the following:

- 0: Toll Saver (see page 1-29).
- 2: The unit answers on the second ring (default).
- 3: The unit answers on the third ring.
- 4: The unit answers on the fourth ring.
- *: The unit will not ring (RINGER OFF).

HELPFUL HINTS:

- If you wish to have the opportunity to pick up the handset before the call is answered by the unit, set the number of rings to "3" or "4".
- If you find there is difficulty in fax receiving from machines that have an automatic transmission feature, set the number of rings to "2".
- To confirm from the remote phone whether a new incoming message has been recorded or not (see pages 4-19 to 4-24), select the Toll Saver position. This will save you the toll charge for the call.

1

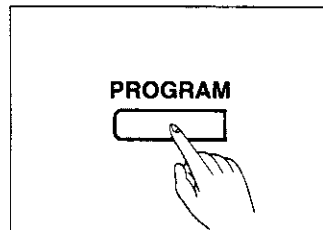

Press the **PROGRAM** button.

The display shows "P- ".

2

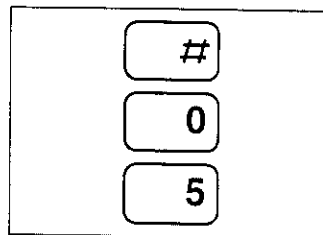

Press #, then press **05**.

The display shows "P-F05 2".

3

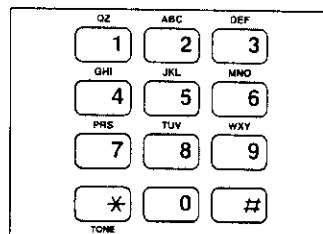

Press the number of the selection you desire.

Setting selections are:

- 0: Toll Saver
- 2: two rings
- 3: three rings
- 4: four rings
- *: Ringer Off

4

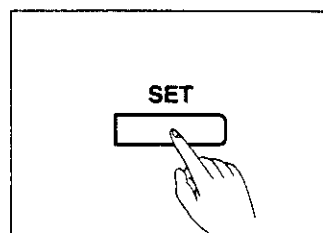

Press the **SET** button to store your selection into memory.

The display shows "P- ".

(continued)

5

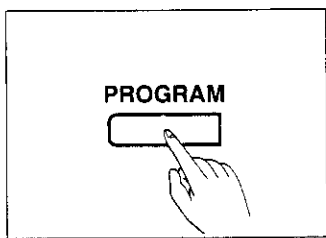

Press the **PROGRAM** button to end the operation.

The display shows the current time.

Toll Saver:

When you call the unit from a remote location, the number of rings tells you if there are any new voice-messages.

If the unit answers on the second ring, there is at least one new message recorded.

If the unit answers on the fourth ring, there are no new messages recorded.

Hang up immediately when you hear the third ring. The third ring indicates that there are no new messages. This will save you the toll charge for the call.

NOTE:

If you set the RINGER OFF through the ANS/FAX RING COUNT function, the extension phone connected to the unit will ring twice when receiving a call.

Selecting the number of rings to answer in the FAX mode

When in the FAX mode, the unit will automatically answer on the second ring when receiving a call. If you wish to change the number of rings to answer a call, you can choose the number among "2" (two rings) through "4" (four rings).

HELPFUL HINTS:

- If you wish to have the opportunity to pick up the handset before the call is answered by the unit, set the number of rings to "3" or "4".
- If you find there is difficulty in fax receiving from machines that have an automatic transmission feature, set the number of rings to "2".

1

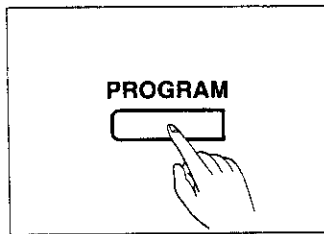

Press the **PROGRAM** button.

The display shows "P- ".

2

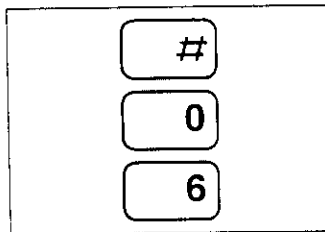

Press #, then press **06**.

The display shows "P-F06 2".

3

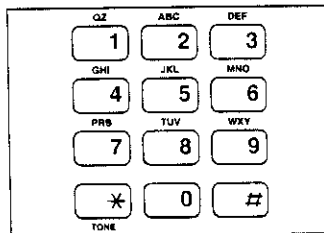

Press the number of the selection you desire.

Setting selections are:

- 2: two rings
- 3: three rings
- 4: four rings

4

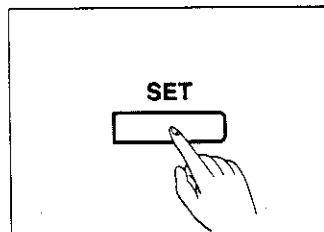

Press the **SET** button to store your selection into memory.

5

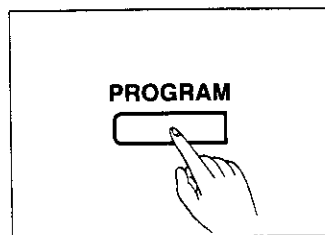

Press the **PROGRAM** button to end the operation.

The display shows the current time.

Selecting the caller's recording time

You can choose from two lengths of recording times for incoming messages.

VOX: The unit records an incoming message as long as a caller speaks (default).

1 MIN: The unit records an incoming message up to 1 minute per message.

To change the recording time, proceed as follows:

1

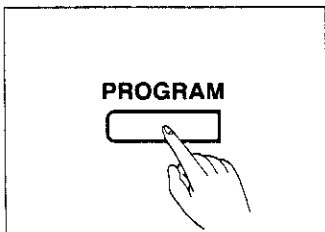

Press the **PROGRAM** button.

The display shows "P- ".

2

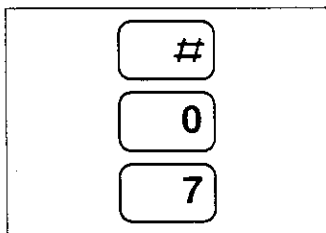

Press #, then press **07**.

The display shows "P-F07 1".

3

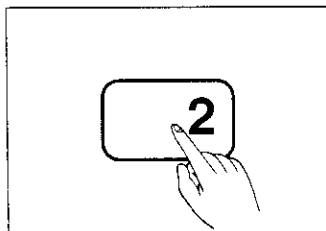

Press **2** by using the dial keypad.

Setting selections are:

1: VOX (unlimited)

2: 1 MIN (1 minute)

4

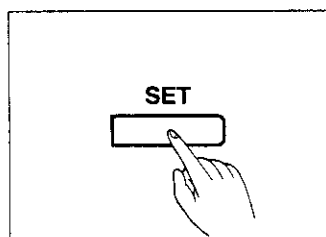

Press the **SET** button to store your selection into memory.

5

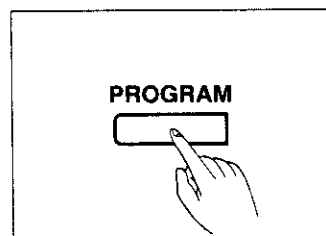

Press the **PROGRAM** button to end the operation.

The display shows the current time.

Setting the remote code (REMOTE TAD ID) for remote TAD operation

The REMOTE TAD ID is used to access your answering device (TAD) from a remote location with a touch tone phone. See pages 4-19 to 4-24.

Using this code, you can retrieve incoming messages recorded on the microcassette tape from a remote location.

The REMOTE TAD ID is preset to 111. If you wish to change the number, you can choose any number from 111 to 999 except numbers including "0".

For proper operation, make sure that the REMOTE TAD ID number is different from your PRIVACY RING ID number (see page 4-25).

1

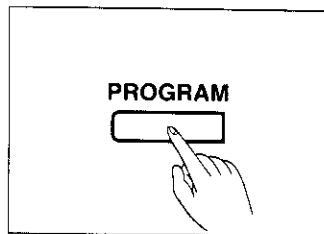

Press the **PROGRAM** button.

The display shows "P- ".

2

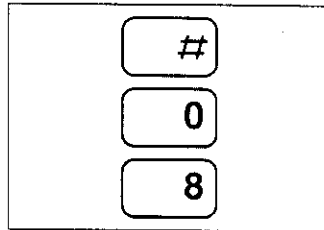

Press #, then press **08**.

The display shows "P-F08 111".

3

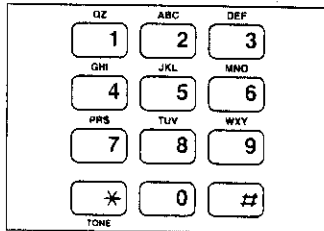

Enter the desired REMOTE TAD ID using the dial keypad.

To correct an error while programming, press the STOP/CLEAR button then correct input.

4

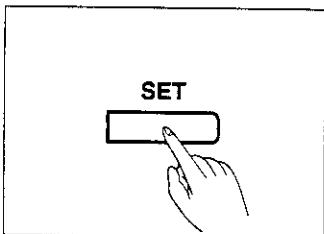

Press the **SET** button to store your selection into memory.

The display shows "P- ".

5

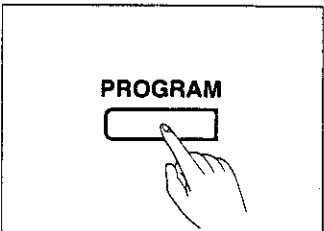

Press the **PROGRAM** button to end the operation.

The display shows the current time.

NOTE:

We recommend that you do not use seven (7) as a code number, since this number is used as the greeting message re-recording command for remote operations.

HELP Function —If you have lost your procedures—

The HELP button is used to print information about how to send documents, how to set up your unit and how to store phone numbers.

Using the HELP button

- Press the HELP button when the unit is in the idle status.
The following is printed out.

HOW TO SEND A FAX:

- FOLLOW INITIAL SET UP PROCEDURES BELOW.
1. INSERT DOCUMENT FACE DOWN.
 2. PRESS "SP-PHONE". (LIGHTS)
 3. DIAL FAX NUMBER OF PARTY YOU WISH TO SEND TO.
 4. WAIT FOR FAX TONE THEN PRESS "START". (SP-PHONE LIGHT GOES OFF)

HOW TO SET UP YOUR FAX:

1. PRESS "PROGRAM".
2. PRESS "#", THEN THE NUMBER OF THE FEATURE YOU WISH TO SET USING THE DIAL KEY-PAD. (SEE LIST OF FEATURES BELOW)
3. ENTER CHOICE OR DATA.
4. IF YOU ENTERED #99 PRESS "START". OTHERWISE PRESS "SET" TO STORE YOUR SELECTION.
5. PRESS "PROGRAM" TO END SET UP.

BASIC FEATURE LIST:

#01 SET DATE = Jan. 01 1993 12:00AM
#02 YOUR LOGO (I.E. COMPANY OR INDIVIDUAL NAME) = Panasonic TAD FAX
#03 YOUR TELEPHONE NUMBER =
#04 PRINT TRANSMISSION REPORT = ERROR (1=ON 2=ERROR 3=OFF)

PROGRAM".

2. PRESS DIRECT CALL STATION OR PRESS "AUTO DIAL"
4. ENTER PHONE NUMBER USING THE DIAL KEY-PAD.
5. PRESS "SET" TO STORE PHONE NUMBER.
- TO STORE IN SUCCESSION, REPEAT STEPS 2 TO 5.
6. PRESS "PROGRAM" TO END SET UP.

HOW TO PRINT A LIST OF YOUR PROGRAMMED TELEPHONE NUMBERS:

1. PRESS "PROGRAM".
2. PRESS "#", THEN "2" "7".
3. PRESS "START".

HOW TO USE ONE TOUCH & AUTO DIALING

- (TO SEND A FAX)
1. INSERT DOCUMENT FACE DOWN.
 2. PRESS ANY STATION OR PRESS "AUTO DIAL" AND 2-DIGIT NUMBER(00 TO 27).

(TO MAKE A PHONE CALL)

 1. LIFT HANDSET OR PRESS "SP-PHONE".
 2. PRESS ANY STATION OR PRESS "AUTO DIAL" AND 2-DIGIT NUMBER(00 TO 27).

HOW TO RECORD A GREETING MESSAGE:

1. OPEN "ANSWERING CONTROL" PANEL.
2. PRESS "REC".
3. SPEAK INTO THE MICROPHONE. (UP TO 16 SECS)
4. WHEN FINISHED, PRESS "STOP" OR "REC" AGAIN.

PRIOR TO LEAVING:

CONFIRM THAT THE ANS FAX INDICATOR IS LIT.

HOW TO PLAYBACK ONLY NEW MESSAGES

PRESS "NEW MESSAGES".

HOW TO PLAYBACK ALL THE RECORDED MESSAGES

PRESS "ALL MESSAGES".

- Press the **HELP** button while programming each feature (#01 through #08, #10 and #11).

Example:

When you wish to program the **SET DATE** (#01),

1. Press the **PROGRAM** button.
The display shows "P- ".

2. Press #, then press **01** for **SET DATE** setting.
The display shows "P-F01 01-01 1993".

3. When you wish to know how to continue programming, press the **HELP** button.

The following is printed out.

HOW TO SET THE CLOCK:
1. ENTER THE MONTH, DAY AND YEAR USING THE DIAL KEYPAD.
2. PRESS "SET" TO STORE.
3. ENTER THE HOUR AND MINUTE USING THE DIAL KEYPAD.
PRESSING "*" ALTERNATELY CHANGES AM/PM.
4. PRESS "SET" TO STORE.

4. Resume programming.

Chapter 2

Basic Instructions

Table of contents

Facsimile and Copier

Before Transmitting Documents	2-2
Acceptable documents	2-2
Documents you cannot send	2-2
Resolution and contrast	2-3
Loading documents	2-3
Transmitting Documents	2-4
Manual transmission	2-4
Adding extra pages	2-5
Receiving Documents and/or Voice Calls	2-6
Manual reception	2-6
Automatic reception	2-7
Receiving in the ANS/FAX mode	2-7
Receiving in the TEL/FAX mode	2-8
Receiving in the FAX mode	2-8
Making a Copy	2-9

Answering Device

Operating as an Answering Device	2-10
Setup of voice message and document reception	2-11
Listening to newly recorded messages	2-11
Listening to all the recorded messages	2-12
Recording after the messages you want to save	2-12
Monitoring incoming calls	2-13
Recording a memo message	2-13
Recording a telephone conversation (2-way recording)	2-14

Telephone

Making and Answering Voice Calls	2-15
Making voice calls	2-15
Redialing the last dialed number	2-16
Answering voice calls	2-16

When the display shows "E-XX", see page 6-2 for corrective measures.

Before Transmitting Documents

Acceptable documents

The unit can transmit documents that meet the following conditions.

- Documents width should be from 128 mm to 216 mm.
- Maximum document length should not exceed 600 mm.
- Effective scanning width can be up to 208 mm.
- Number of pages that can be set in the document feeder tray can be up to 10 sheets.
- Document weight:
 - Single sheet: 45 g/m² to 90 g/m²
 - Multiple sheets: 60 g/m² to 75 g/m²

Minimum document size

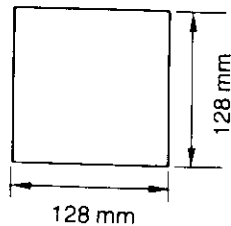

Maximum document size

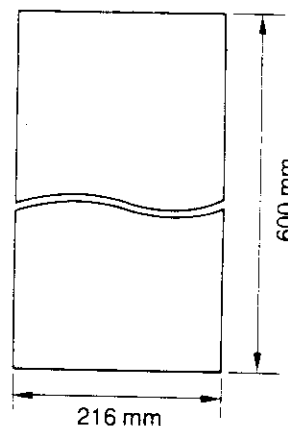

Effective scanning width

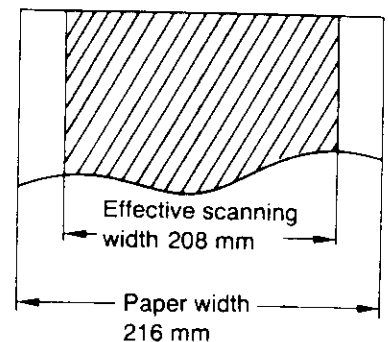

NOTES:

- A document whose length exceeds 600 mm cannot be transmitted. When you feed such documents, the unit will stop transmitting and a long beep will be heard. If this happens, press the STOP/CLEAR button and remove the document.
- If a document is electrostatically charged, the automatic document feeder may not function properly.

Documents you cannot send

Do not use the following types of documents or they may jam. Make a copy of such documents and feed the copy into the unit.

- Paper with a chemically treated surface such as carbon paper or carbonless duplicating paper
- Heavily curled, creased or torn paper
- Paper with a coated surface
- Small-sized paper such as a slip or voucher
- Thin paper less than 45 g/m²
- Thick paper over 90 g/m²
- Paper with faint contrast between the print and the background
- Paper with printing on the reverse side that can be seen through from the front (e.g. newspaper)

Resolution and contrast

You can set the following functions depending on the quality of an original. Set the functions before transmission or copying. If you set them during transmission, they will be effective from the next sheet transmitted.

RESOLUTION:

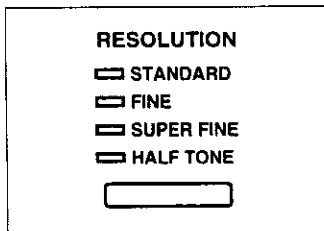

STANDARD is suitable for printed or typewritten originals with normal-sized characters.

FINE is suitable for originals with small printing.

SUPER FINE doubles the resolution of FINE. (SUPER FINE only works between Panasonic compatible machines such as KX-F2350 and KX-F2450.)

HALF TONE is useful when sending originals containing photographs, shaded drawings, etc.

LIGHT ORIGINAL:

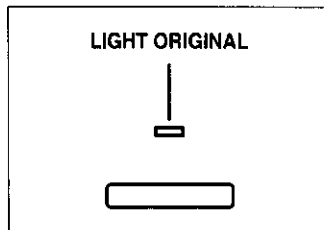

LIGHT ORIGINAL is useful when transmitting or copying originals with faint writing.

This feature does not work in the HALF TONE resolution.

Loading documents

Remove clips, staples or other similar objects from a document before feeding it into the unit. Check that all ink, paste or connection fluid on the document is completely dry before feeding it into the unit.

1

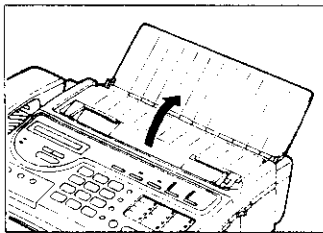

Open the document feeder tray.

2

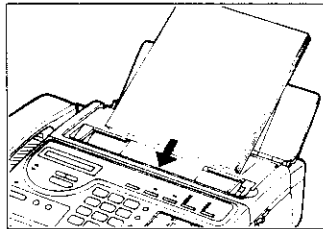

Insert the documents FACE DOWN into the document feeder tray.

The unit can accept up to 10 sheets of paper at a time.

3

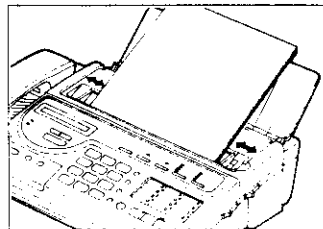

Adjust the document guides to the width of the document.

4

Set the resolution or contrast setting if needed.

Transmitting Documents

Manual transmission

1

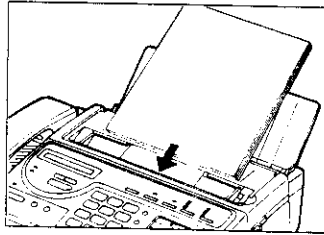

Insert the documents **FACE DOWN**.

The unit can accept up to 10 sheets of paper at a time.

2

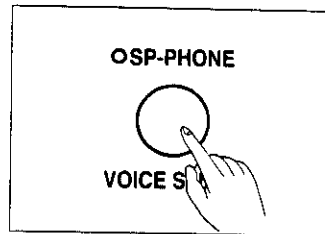

Press the **SP-PHONE** button or lift the handset.

3

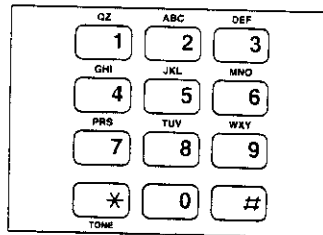

Dial the phone number of the party to which you wish to send.

If the other party answers, ask them to press their start or transmit button to start the fax reception.

4

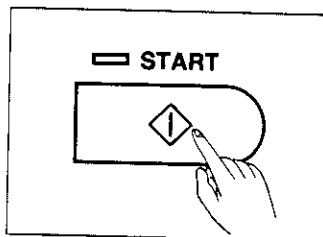

Press the **START** button when a fax tone is heard.

5

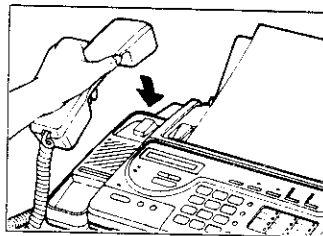

Place the handset on the cradle if using it.

The unit will feed and transmit the documents. The display will show the number of each page (01 through 99) during a fax transmission.

NOTES:

- If you do not replace the handset after pressing the **START** button, the unit will automatically call the other party upon finishing the transmission. For further details, see "Voice Contact" on page 4-28.
- If the line is busy, press the **SP-PHONE** button or hang up the handset if using it. Then try again later by using the **REDIAL** button in step 3.
- To interrupt transmission, press the **STOP/CLEAR** button until a beep sounds. Press the **STOP/CLEAR** button again to eject the document.

You can also access the other party's facsimile without using the handset or the SP-PHONE button.

This feature enables you to transmit a document with less procedures.

1

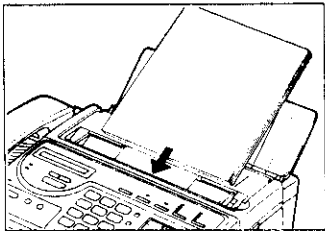

Insert the documents FACE DOWN.

2

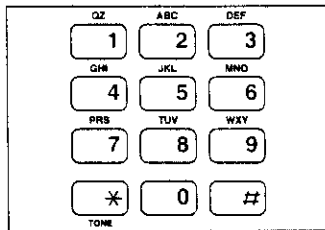

Enter the phone number of the party to which you wish to send.

Confirm in the display whether the phone number is correctly dialed. If you misdial, press the STOP/CLEAR button then enter the correct number.

3

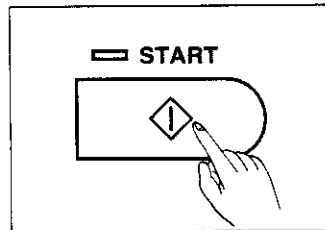

Press the **START** button.

The unit will dial and transmit the documents.

Automatic redialing feature:

If there is no answer or the line is busy, the unit will automatically redial the number up to 3 times. To cancel automatic redialing, press the STOP/CLEAR button.

NOTE:

To interrupt transmission, press the STOP/CLEAR button until a beep sounds. Press the STOP/CLEAR button again to eject the document.

Adding extra pages

If you want to send 11 or more sheets at a time, insert the first ten pages of document and add the extra pages, up to 10 sheets at a time before the last page is fed into the unit.

Receiving Documents and/or Voice Calls

Manual reception

When in the TEL mode or during a telephone conversation, you can receive fax documents as follows.

1

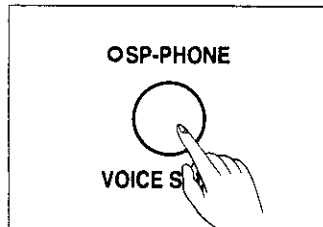

When the phone rings, lift the handset or press the **SP-PHONE** button to answer the call.

2

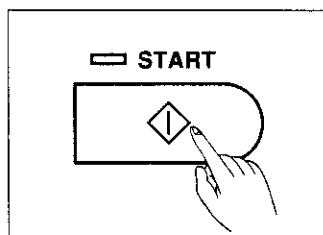

When a voice is heard and document reception is required, press the **START** button.

3

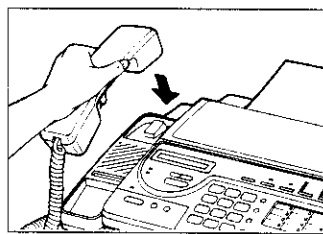

Place the handset on the cradle if using it.

The unit will start receiving a document.
The display will show the number of each page (01 through 99).

NOTES:

- If you do not replace the handset after pressing the START button, the unit will automatically call the other party. For further details, see "Voice Contact" on page 4-28.
- To interrupt reception, press the STOP/CLEAR button. The unit will stop receiving.
- Replace the paper roll with a new one;
 - when the red lines appear on both sides of the recording paper.
 - when the PAPER OUT indicator lights.
 - when the display shows "E-06".

Automatic reception

Set the RECEIVE MODE to any of the following modes:

- ANS/FAX mode
- TEL/FAX mode
- FAX mode

When receiving a fax call, the unit will automatically switch to the fax mode, then initiate reception.

Receiving in the ANS/FAX mode

1

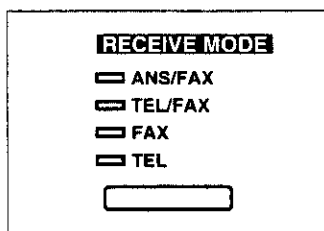

Make sure that the unit is in the ANS/FAX mode.

2

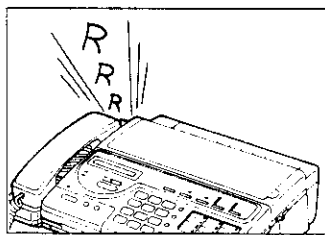

A call comes in.

The unit answers the call after 2 to 4 rings or no rings, depending on the number of rings after which the unit is set to answer. See page 1-28.

3

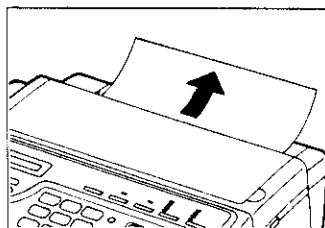

—When receiving a fax tone, the unit automatically activates the fax function to receive documents.

—When receiving a voice-call, the unit plays your greeting message.

HELPFUL HINTS:

- If the other party wishes to leave you a message and transmit a document on the same call, let them know the following procedure in advance.

When the other party's line has touch tone service:

1. After leaving a message, the other party presses their * button.
Your unit will switch to the FAX mode.
2. When a fax tone is heard, they start transmission by pressing their start or transmit button.

When the other party's line has rotary pulse service:

1. They start transmission by pressing their start or transmit button.
Your unit starts reception.
2. They make a call reservation (e.g. ... lift the handset) during transmission of their document.
Your unit plays your greeting message.
3. They leave a message after the long beep following your greeting message.

- Begin by transmitting the FAX CORRESPONDENCE leaflet found on page 6-17 to several of your associates. In this way you can confirm that your unit is functioning correctly and inform them of the procedure for transmitting documents and/or recording voice-message on your unit.

NOTE:

If you set the RINGER OFF through the ANS/FAX RING COUNT function, the extension phone connected to the unit will ring twice when receiving a call. See page 1-28 for the RINGER OFF setting.

Receiving in the TEL/FAX mode

1

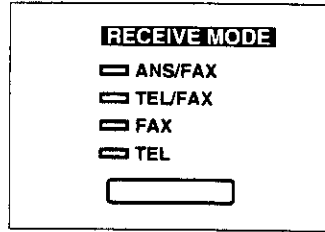

Make sure that the unit is in the TEL/FAX mode.

2

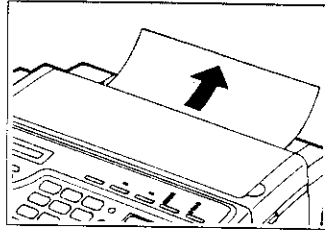

A call comes in.

—**When receiving a fax tone**, the unit automatically activates the fax function to receive documents.

OR

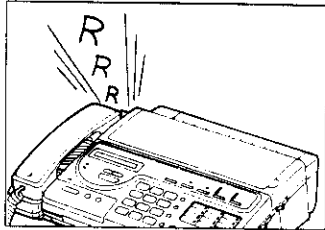

OR

—**When receiving a telephone call**, the unit rings 3 to 8 times, depending on the setting of the silent fax recognition ring. See page 4-33.

If a fax reception is required or nothing is heard, press the START button and hang up to receive a fax.

If someone does not pick up the phone, the unit automatically activates the fax function to receive documents.

NOTES:

- A telephone fee is charged to callers from the first ring.
- When receiving a fax tone, the extension phone connected to the unit will ring twice and then the unit automatically activates the fax function to receive documents.

Receiving in the FAX mode

1

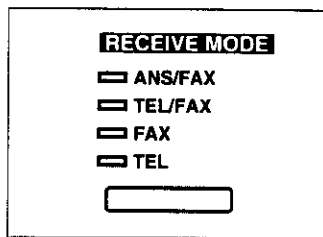

Make sure that the unit is in the FAX mode.

2

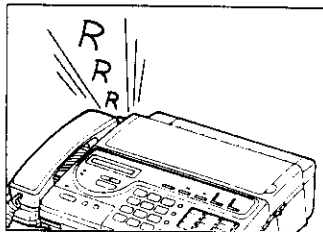

A call comes in.

The unit answers the call after 2 to 4 rings, depending on the number of rings after which the unit is set to answer. See page 1-30.

3

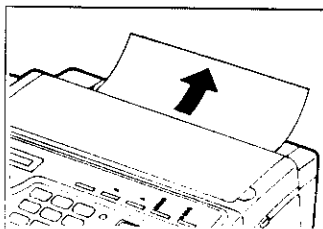

The unit produces a fax tone, then starts receiving a document when the other party presses their start or transmit button.

Making a Copy

The unit can make a copy. Any transmissible documents can be copied. Before sending a document, you can see how it will look to the receiving party in advance. When copying, the unit automatically selects the FINE resolution, but you may use SUPER FINE or HALF TONE resolution.

1

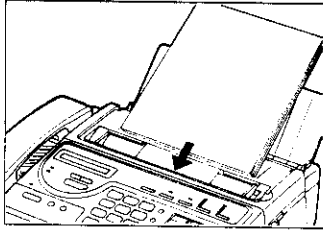

Insert the documents **FACE DOWN**.

The unit can accept up to 10 sheets of paper at a time.

2

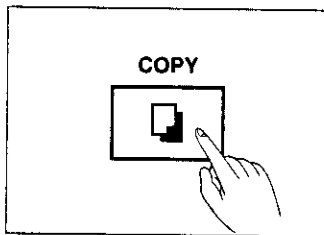

Press the **COPY** button.

The unit starts making a copy.

NOTES:

- To stop making a copy on the way, press the STOP/CLEAR button. The unit stops copy operation. Press the STOP/CLEAR button again to eject the document.
- When the Paper Save function is set to ON and the STANDARD resolution is selected, the unit will make a copy half the size of the original. See page 4-17.

Operating as an Answering Device

The unit also works as an automatic telephone answering and recording system.

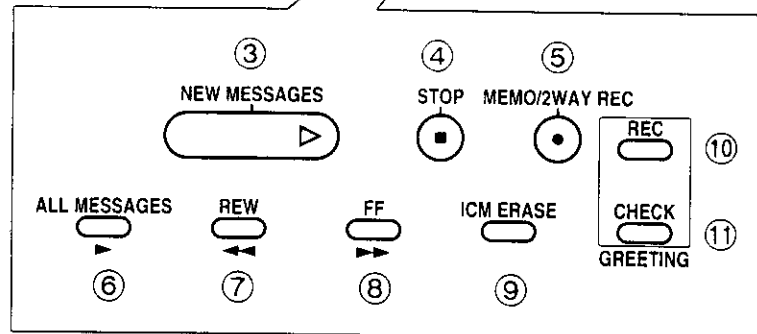
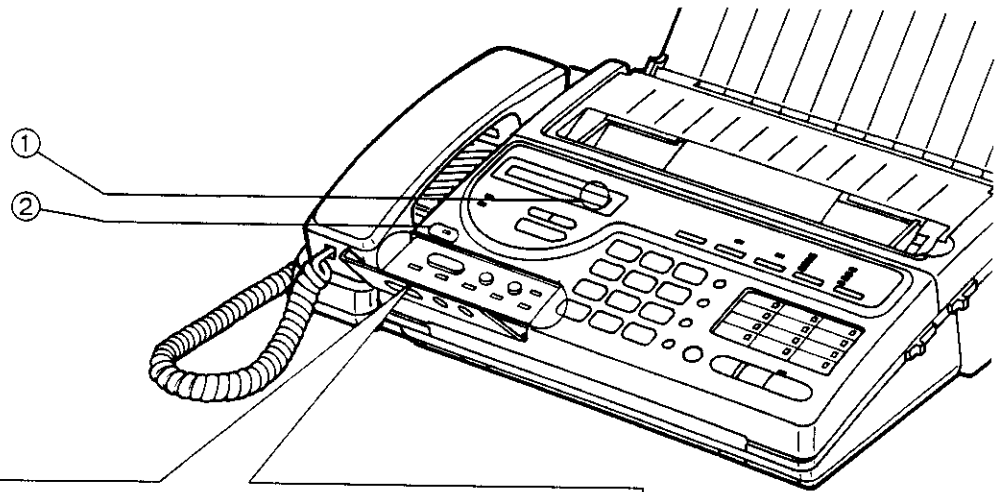

Basic Instructions

- ① **Call counter:**
The number of recorded incoming voice-messages is shown on the display.
- If the power supply has been interrupted, the call counter shows “--” when the power is restored.
- ② **Indicator:**
When any new incoming messages are recorded, the indicator flashes.
- ③ **Playing back newly recorded voice-messages:**
Press the **NEW MESSAGES** button.
See page 2-11.
- ④ **Stopping operations of the answering device:**
Press the **STOP** button.
- ⑤ **Recording a memo message:**
See page 2-13.
- Recording a telephone conversation:**
See page 2-14.
- ⑥ **Playing back all recorded messages:**
Press the **ALL MESSAGES** button.
See page 2-12.
- ⑦ **Rewinding (Resetting) the tape quickly:**
Press the **REW** (Rewind) button.
- ⑧ **Advancing the tape quickly:**
Press the **FF** (Fast Forward) button.
- ⑨ **Erasing recorded voice-messages:**
After reviewing messages to you, press the **ICM ERASE** button. The messages are erased while the tape is rewinding.
- The tape can be erased at high speed even if the record-prevention (knock-out) tabs have been removed.
- ⑩ **Recording your greeting message:**
See page 1-15.
- ⑪ **Checking your greeting message:**
See page 1-15.

Setup of voice message and document reception

1

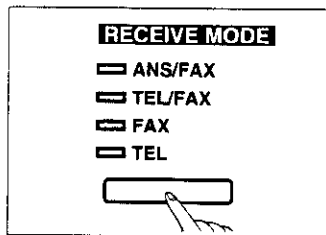

Press the **RECEIVE MODE** button until the ANS/FAX indicator lights.

2

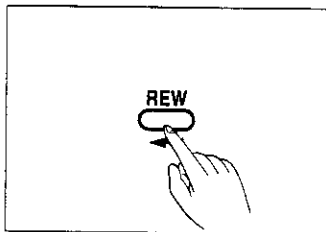

Press the **REW** button to record messages from the beginning of the tape.

When a call is received, the unit answers the call and begins playback of your greeting message. The unit automatically distinguishes between voice and fax calls, and then functions as an answering device and/or a facsimile.

NOTE:

The recording time for incoming messages can be set to VOX (unlimited) or 1 MIN (1 minute). It is preset to VOX. To change the recording time, see page 1-31.

Listening to newly recorded messages

When new incoming messages have been recorded, the call counter shows the number of recorded messages (01 to 99) and the  indicator flashes.

To play back only new messages:

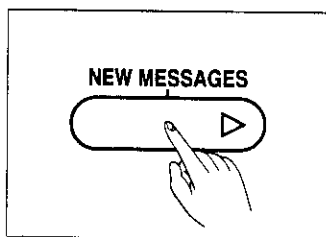

Press the **NEW MESSAGES** button.

The unit plays back new messages.
At the end of the last message, 3 beeps sound and the tape stops automatically.

NOTES:

- The unit is equipped with the message alert feature. When this feature is set to on, the unit lets you know with a slow beep whether a caller's message has been recorded in the unit or not. To set this feature, see page 4-27.
- To interrupt the playback halfway, press the STOP button. To restart the playback, press the NEW MESSAGES button within one minute after pressing the STOP button. Or the unit will record over any existing messages.

Listening to all the recorded messages

All the recorded messages will be played back from the beginning of the tape.

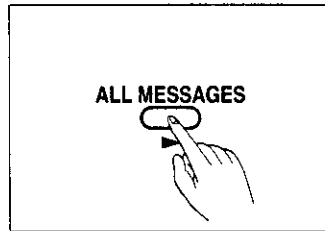

Press the **ALL MESSAGES** button.

The unit plays back all the recorded messages. At the end of the last message, 3 beeps sound and the tape stops automatically.

NOTE:

To interrupt the playback halfway, press the **STOP** button.

To restart the playback, press the **ALL MESSAGES** button within one minute after pressing the **STOP** button. Or the unit will record over any existing messages.

Recording after the messages you want to save

New incoming messages will be automatically stored after the last message. If you want to store incoming messages after your saved messages, proceed as follows.

1

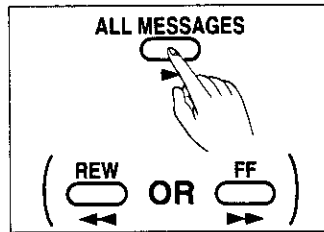

Play back the messages.

You may use the **ALL MESSAGES**, **FF** or **REW** button.

2

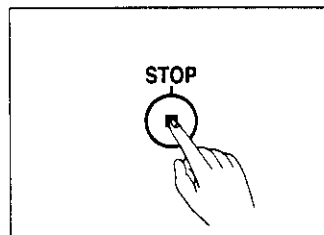

Press the **STOP** button at the end of the messages you want to save.

3

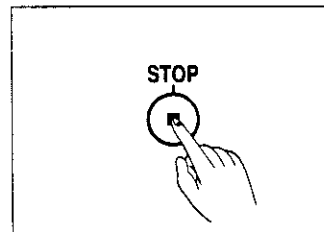

Press the **STOP** button again.

OR

Leave the unit for one minute.

Future calls will be recorded after the message(s) you have saved.

Monitoring incoming calls

While an incoming message is being recorded, you can monitor the caller's voice through the built-in speaker and answer it if you want.

Adjust the sound level using the **VOLUME** control.

To answer the call while monitoring, lift the handset or press the **SP-PHONE** button. The unit stops recording automatically.

Recording a memo message

If you are going out and you want to leave a private message for someone, you can record a voice memo in the unit. This can then be played back either directly or remotely, exactly like any other incoming message.

1

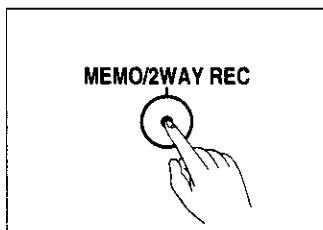

Press the **MEMO/2WAY REC** button.

A beep is heard.

2

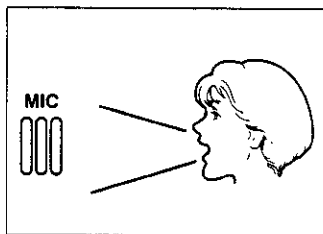

Speak toward the microphone from approximately 20 cm away.

3

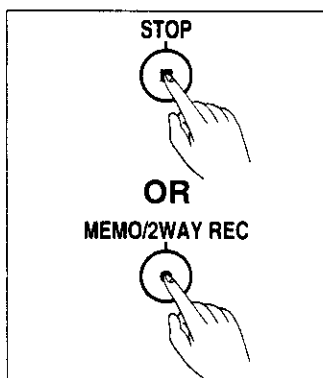

To stop recording, press the **STOP** button or the **MEMO/2WAY REC** button again.

The call counter on the display increases by one and the  indicator flashes.

Recording a telephone conversation (2-way recording)

While speaking with someone on the telephone, you can record your conversation.

1

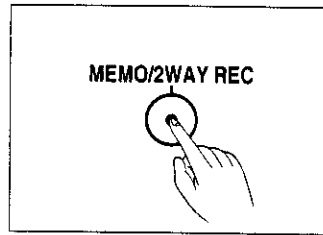

During your conversation, press the **MEMO/2WAY REC** button.

A beep is heard.

2



Continue your conversation.

3

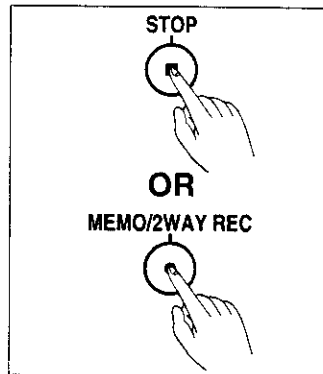

To stop recording, press the **STOP** button or the **MEMO/2WAY REC** button again.

The call counter on the display increases by one and the  indicator flashes.

Making and Answering Voice Calls

Making voice calls

Using the handset

1. Lift the handset.
2. Dial the phone number.

Using the speaker phone

1

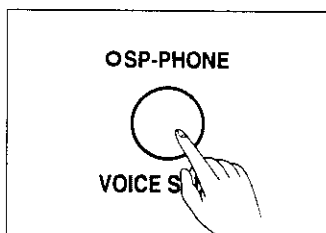

Press the **SP-PHONE** button.

The SP-PHONE indicator lights.

2

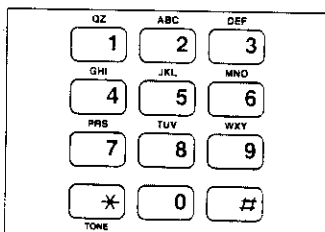

Dial the phone number.

The dialed number is displayed.

3

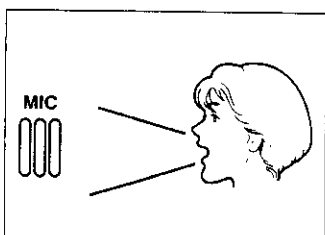

When the other party answers, speak with them through the Microphone (MIC).

To switch to the handset call, lift the handset.

4

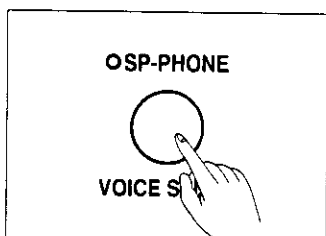

When finished, press the **SP-PHONE** button.

Replace the handset on the cradle if using it.

HELPFUL HINTS FOR THE SPEAKER-PHONE OPERATION:

- Use the speakerphone in a quiet room for best performance.
- If the other party has difficulty hearing you, decrease the volume using the **VOLUME** control. (See page 1-3.)
- If you and the other party speak at the same time, parts of your conversation will be lost. To avoid this, speak alternately.

Redialing the last dialed number

If the line is busy or you wish to redial the last dialed number, you can redial by pressing the REDIAL button.

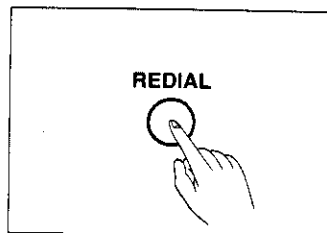

Press the **REDIAL** button.

- **When using the handset**, the unit redials the last dialed number once.
- **When using the speaker phone**, the unit redials the last dialed number up to 3 times at an interval 65 seconds if the line is busy (automatic redialling feature).

Answering voice calls

When the phone rings, lift the handset or press the SP-PHONE button to answer the call.

When you have finished, replace the handset or press the SP-PHONE button.

NOTE:

For helpful hints for speakerphone operation, see page 2-15.

Chapter 3

Intermediate Instructions

Table of contents

Storing Phone Numbers for Automatic Dialing	3-2
Listing the directory card	3-2
Storing phone numbers for one touch dialing	3-3
Storing phone numbers for speed dialing	3-4
Storing secret phone numbers	3-5
Erasing a stored phone number	3-6
<i>Facsimile</i>	
Transmitting Documents Using Automatic Dialer	3-7
<i>Telephone</i>	
Making Voice Calls Using Automatic Dialer	3-8

When the display shows "E-XX", see page 6-2 for corrective measures.

Storing Phone Numbers for Automatic Dialing

The unit's memory allows you to use both one touch dialing (up to 12 phone numbers) and speed dialing (up to 28 phone numbers) for rapid access to your most frequently dialed numbers. First make sure the DIALING MODE selector is set to TONE or PULSE (rotary) mode, since the number will be stored in the mode that is set at the time of programming.

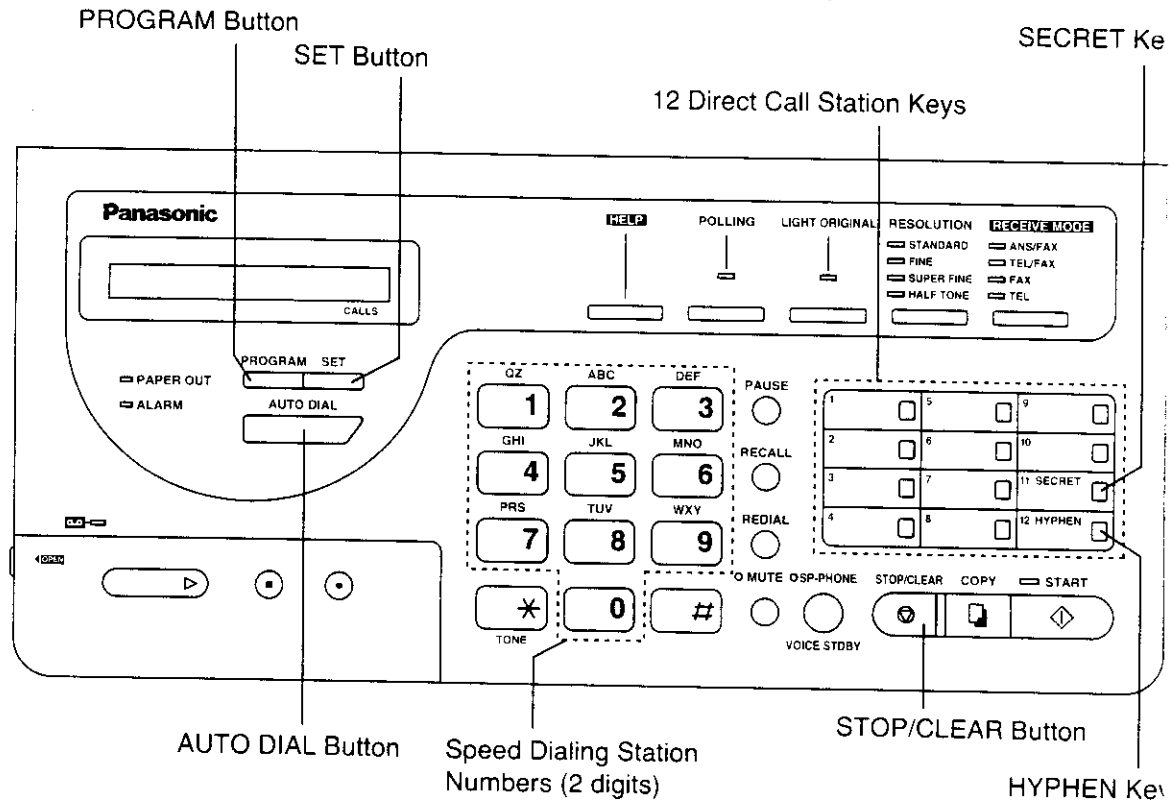

Listing the directory card

1. Remove the cover using an instrument with a pointed end, like a pen, as shown below.
2. Remove the directory card.
3. Write in the names associated with the direct call station keys.
4. Re-install the directory card.

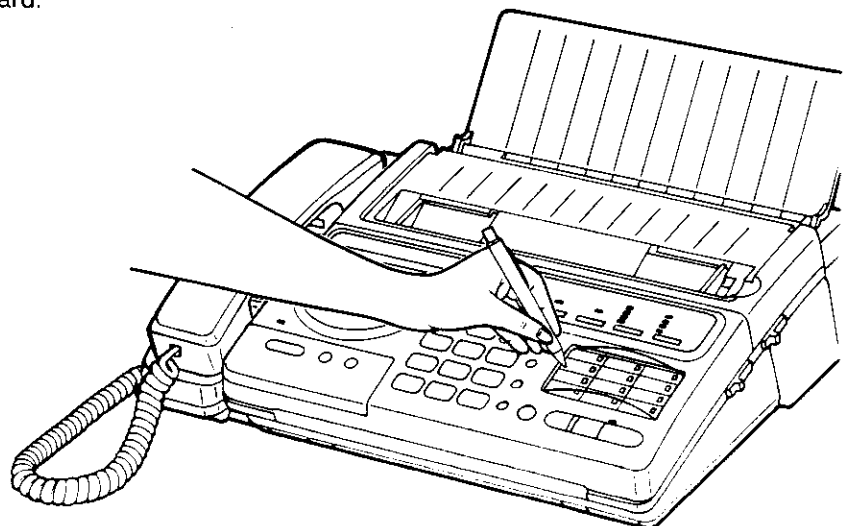

Storing phone numbers for one touch dialing

This unit is equipped with 12 direct call station keys including SECRET and HYPHEN keys, each of which can store a telephone number. Each phone number can be programmed up to 30 digits long.

1

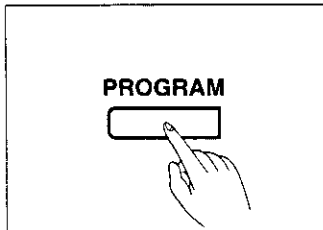

Press the **PROGRAM** button.

The display shows "P- ".

2

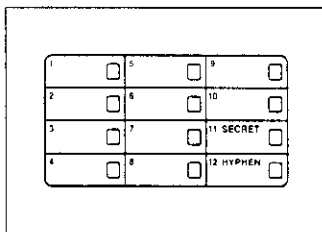

Press one of the direct call station keys where you want to store the phone number.

Example: If you select the station key 1, the display shows "P-d01 ".

3

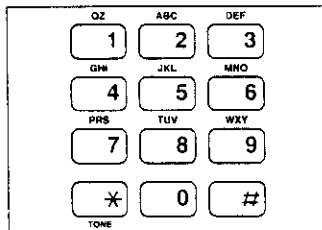

Enter the phone number by using the dial keypad.

If you want to insert a hyphen in the number, press the HYPHEN key during programming. HYPHEN is counted as 2 digits.

4

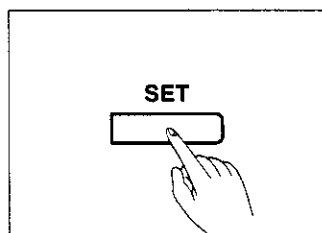

Press the **SET** button to store the program into memory.

The display shows "P- ".

To store in succession, repeat Steps 2 to 4.

5

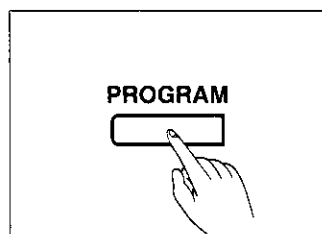

After programming all numbers, press the **PROGRAM** button to end the operation.

The display shows the current time.

NOTES:

- To correct an error while programming, press the STOP/CLEAR button then correct input.
- To cancel the programming halfway, press the PROGRAM button.
- To print out a list of the stored phone numbers, press the PROGRAM button, press #, then press 27, then press the START button. For further details, see pages 5-5 and 5-6.

Storing phone numbers for speed dialing

The unit is equipped with 28 stations (00 through 27), each of which can store a phone number. Each phone number can be programmed up to 30 digits long.

1

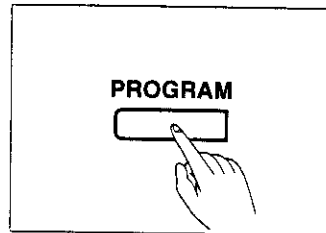

Press the **PROGRAM** button.

The display shows "P-".

2

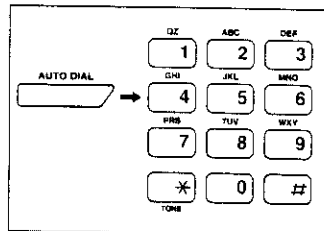

Press the **AUTO DIAL** button.

Enter the 2-digit number (00 through 27) by using the dial keypad.

Example: If the station number is 00, the display shows "P-A00".

3

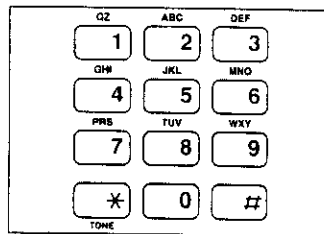

Enter the phone number by using the dial keypad.

To insert a hyphen in the number, press the HYPHEN key during programming. HYPHEN is counted as 2 digits.

4

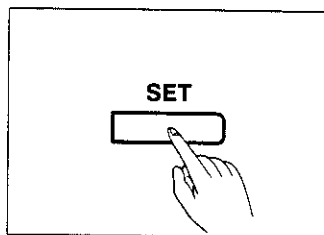

Press the **SET** button to store the program into memory.

The display shows "P- ".

To store in succession, repeat Steps 2 to 4.

5

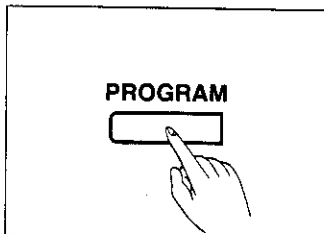

After programming all the numbers, press the **PROGRAM** button to end the operation.

The display shows the current time.

NOTES:

- To correct an error while programming, press the STOP/CLEAR button then correct input.
- To cancel the programming halfway, press the PROGRAM button.
- To print out a list of the stored phone numbers, press the PROGRAM button, press #, then press 27, then press the START button. For further details, see pages 5-5 and 5-6.

Storing secret phone numbers

This function is useful for keeping a whole phone number or a portion of a phone number secret. When you print out a list of the stored numbers, secret numbers will not be printed.

1

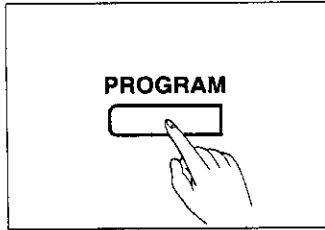

Press the **PROGRAM** button.

The display shows "P-".

2

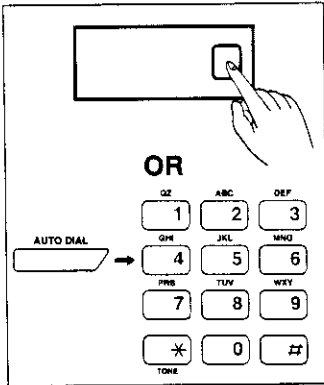

Press one of the direct call station keys.

OR

Press the **AUTO DIAL** button.

Then enter the 2-digit number (00 through 27).

3

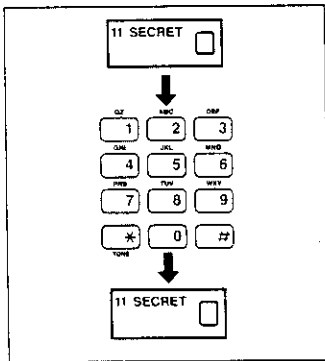

Press the **SECRET** key.

Then enter the phone number.

Then press the **SECRET** key again.

Pressing the **SECRET** key once counts as 2 digits.

4

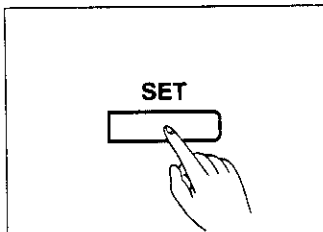

Press the **SET** button to store the program into memory.

5

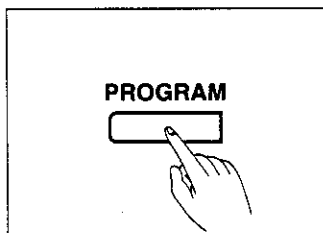

Press the **PROGRAM** button to end the operation.

The display shows the current time.

NOTES:

- To correct an error while programming, press the **STOP/CLEAR** button then correct input.
- To cancel the programming halfway, press the **PROGRAM** button.

Erasing a stored phone number

If you wish to erase a stored phone number, proceed as follows.

1

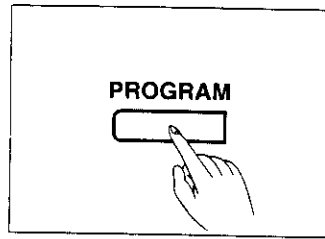

Press the **PROGRAM** button.

The display shows "P- ".

2

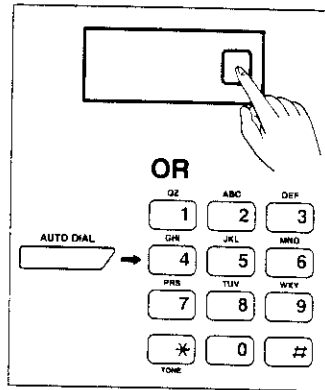

Press one of the direct call station keys.

OR

Press the **AUTO DIAL** button.

Then enter the 2-digit number (00 through 27).

3

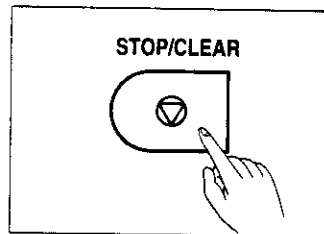

Press the **STOP/CLEAR** button.

4

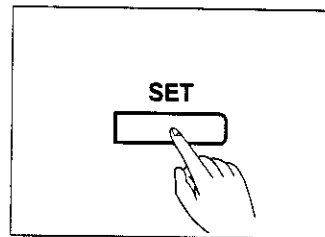

Press the **SET** button.

Now the stored phone number has been erased.

5

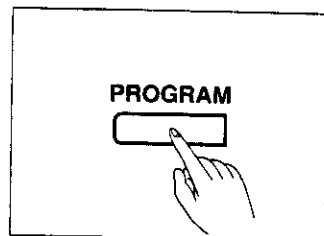

Press the **PROGRAM** button to end the operation.

The display shows the current time.

NOTE:

To cancel the programming halfway, press the PROGRAM button.

Transmitting Documents Using Automatic Dialer

You can transmit documents automatically using one touch dialing and speed dialing. Before using these features, make sure that the desired telephone numbers have been stored into memory. For storing phone numbers, see pages 3-3 to 3-5.

1

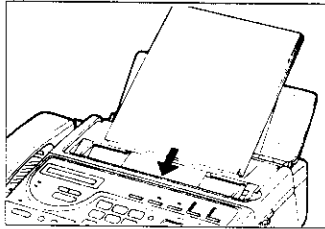

Insert the documents FACE DOWN.

The unit can accept up to 10 sheets of paper at a time.

2

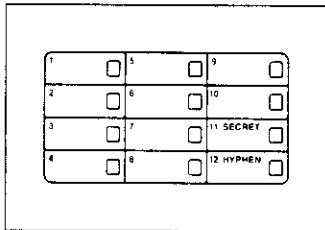

Using one touch dialing:

Press the desired direct call station key.

The unit dials and transmits the documents automatically.

OR

OR

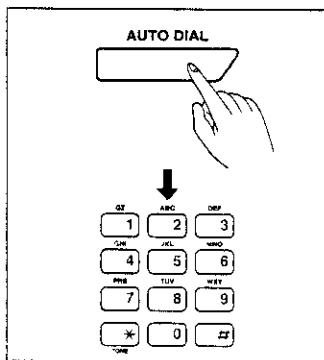

Using speed dialing:

Press the **AUTO DIAL** button.

Then enter the desired 2-digit number (00 through 27) by using the dial keypad.

The unit dials and transmits the documents automatically.

Automatic redialing feature:

If there is no answer or the line is busy, the unit will automatically redial the number up to 3 times. To cancel automatic redialing, press the STOP/CLEAR button.

NOTE:

To interrupt transmission, press the STOP/CLEAR button until a beep sounds. Press the STOP/CLEAR button again to eject the document.

Making Voice Calls Using Automatic Dialer

The unit's memory allows you to use both one touch dialing (up to 12 phone numbers) and speed dialing (up to 28 phone numbers) for rapid access to your most frequently called numbers. Before using these features, make sure that the desired telephone numbers have been stored in memory. See pages 3-3 to 3-5.

1

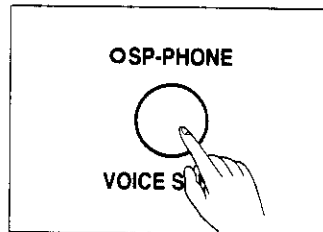

Press the **SP-PHONE** button or lift the handset.

2

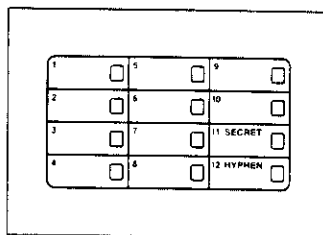

Using one touch dialing:
Press the desired direct call station key.

OR

OR

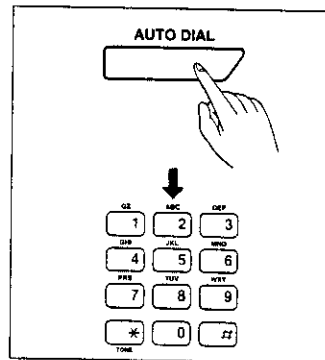

Using speed dialing:
Press the **AUTO DIAL** button.
Then press the desired station number (00 through 27) by using the dial keypad.

Chapter 4

Advanced Instructions

Table of contents

<i>Facsimile and Copier</i>		Skipping the greeting message for incoming message recording mode	4-23
Delayed Transmission	4-2	Re-recording a greeting message	4-24
Polling	4-4	Call with Privacy Ring	4-25
Polling another unit manually	4-4	Programming the PRIVACY RING ID	4-25
Polling another unit using automatic dialer	4-5	Calling with the privacy ring	4-26
Setting the polling password	4-6	Setting the Message Alert	4-27
Network Communication	4-7	<i>Telephone</i>	
Using a passcode	4-8	Voice Contact	4-28
Programming the main passcode	4-9	Initiating voice contact	4-28
Turning the TX passcode check on	4-10	Receiving a request for voice contact	4-28
Turning the RX passcode check on	4-11	TONE, RECALL and PAUSE Button Usage	4-29
Remote Fax Receiving Using an Extension Phone	4-12	TONE button (Temporary tone dialing)	4-29
Using an extension phone	4-12	RECALL button	4-29
Programming a remote fax activation code	4-13	PAUSE button	4-30
Setting the Logo Print Position	4-14	Combination dialing	4-30
Setting a Customized Header	4-15	<i>Other Features</i>	
Setting the Paper Save Function	4-17	Other Features	4-31
Extension Copy	4-18	Setting Day/Night Mode	4-31
<i>Answering Device</i>		Setting the Silent Fax Recognition Ring	4-33
Operating an Answering Device from a Remote Phone	4-19	Setting the Recall Mode	4-34
Summary of remote control functions	4-19	Resetting the setup features	4-35
Playing back newly recorded messages (Memory playback)	4-20		
Playing back all messages	4-20		
Back space and skip forward	4-21		
Recording a marker message	4-21		
Resetting the tape for future messages	4-22		

When the display shows "E-XX", see page 6-2 for corrective measures.

Delayed Transmission

Using a built-in clock, this unit can send documents automatically at a specific time. This allows you to take advantage of low-cost calling hours given by some telephone companies. The delayed transmission can be reserved to take place within 24 hours in advance.

1

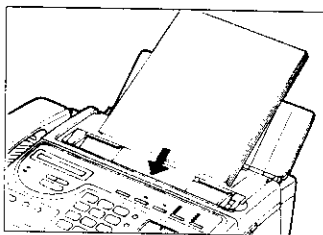

Insert the documents **FACE DOWN**.

The unit can accept up to 10 sheets of paper at a time.

2

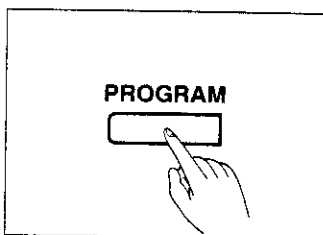

Press the **PROGRAM** button.

The display shows "P- ".

3

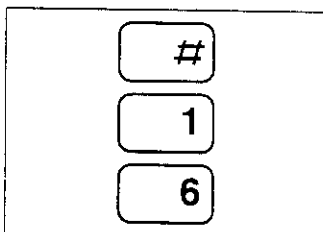

Press #, then press **16**.

The display shows "P-F16 2".

4

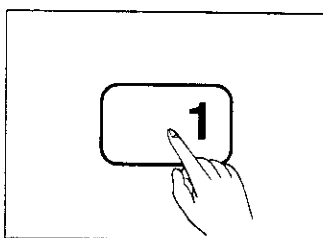

Press 1 to activate this feature.

Setting selections are:

- 1: ON (activate this feature)
- 2: OFF (deactivate this feature)

5

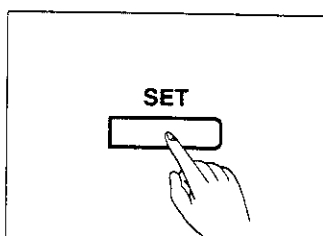

Press the **SET** button to store your selection into memory.

The display shows "AM P-F16 12-00".

6

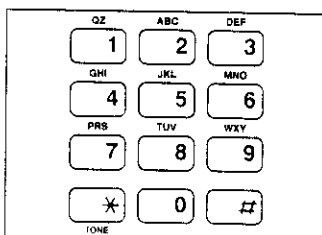

Enter the time at which you want the unit to start transmission.

Example: If the starting time is 11:00PM, press 1100, then press *.

The display shows "PM P-F16 11-00".

AM or PM is alternately selected by pressing *.

(continued)

7

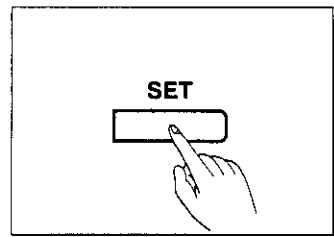

Press the **SET** button to store the program into memory.
The display shows "P-F16 ".

8

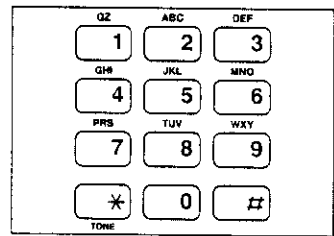

Enter the phone number of the party you wish to transmit using the direct call station key, the speed dial station or a full number.

Example: Speed dial station 00 is dialed.
The display shows "P-F16 A00".

9

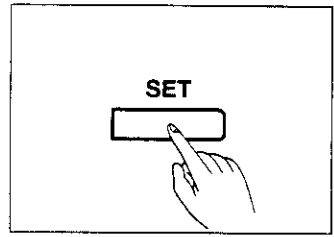

Press the **SET** button to store the program into memory.
The display shows "P- ".

10

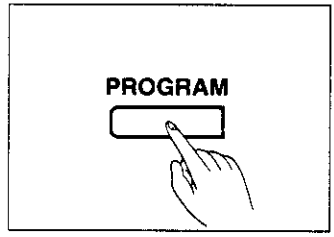

Press the **PROGRAM** button to end the operation.
The display shows "PM 3-50 d11-00P 00".
Now the delayed transmission has been set.
After transmission, the delayed transmission feature will be automatically turned off.

NOTES:

- You can receive, transmit and copy documents while the delayed transmission is set. To copy or transmit documents after setting delayed transmission, remove documents from the tray and replace them when you have finished.
- If there is no answer or the line is busy during the delayed operation, the unit will automatically redial the number up to 3 times.

Polling

Polling means that you call another facsimile machine (we call it "polled machine") to retrieve a document. The other party must be prepared for your call with a document loaded on their machine.

This unit can only receive polled documents; it cannot be "polled".

The unit initiating the call incurs any long distance charges.

Polling another unit manually

The following procedure lets you poll another station.

Make sure that no documents have been fed into the unit and that the polled machine is ready for your call.

1

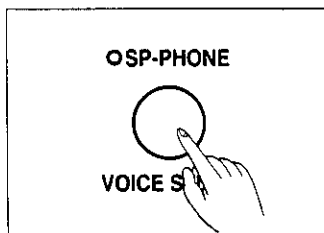

Press the **SP-PHONE** button or lift the handset.

2

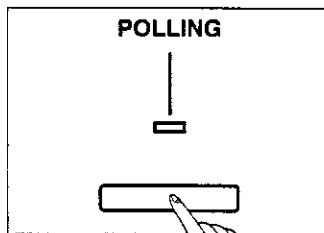

Press the **POLLING** button.

The **POLLING** indicator lights.

3

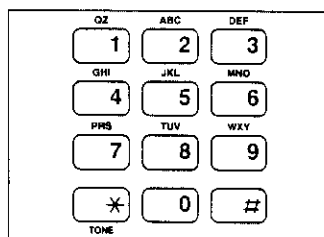

Enter the phone number of the unit you wish to poll.

4

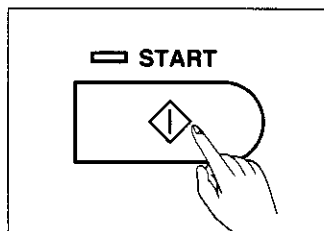

Press the **START** button when a fax tone is heard.

The unit will start polling.

After reception, the **POLLING** indicator goes out.

NOTE:

If you want to cancel polling before reception, press the **STOP/CLEAR** button.

Polling another unit using automatic dialer

Make sure that the desired telephone numbers have been stored into memory. See pages 3-2 through 3-6.

1

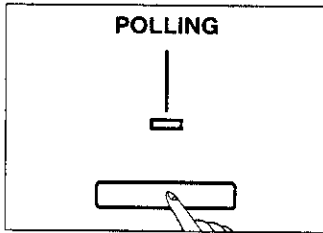

Press the **POLLING** button.

The POLLING indicator lights.

2

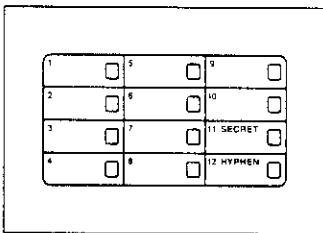

Press the desired direct call station key.

OR

OR

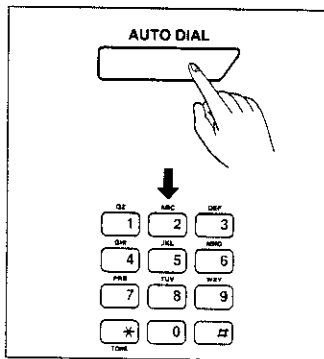

Press the **AUTO DIAL** button.

Enter the desired two-digit number (00 through 27).

The unit will dial and receive documents automatically.
When reception ends, the POLLING indicator goes out.

NOTES:

- If the polled station is busy or there is no answer, the unit will automatically redial the number up to 3 times.
- If you want to cancel polling before reception, press the STOP/CLEAR button.

Setting the polling password

If the document to be retrieved is of a confidential nature and the password is set on the other machine to prevent unauthorized retrieving, you must set the same password on your unit. If the passwords in the polling unit and polled unit do not match, no transmission will take place.

NOTES:

- Polling using a password is effective between other Panasonic compatible facsimile machines (e.g. KX-F95).
- If the polling password is set to "0000", the unit does not check the password sent by other facsimile machines.

1

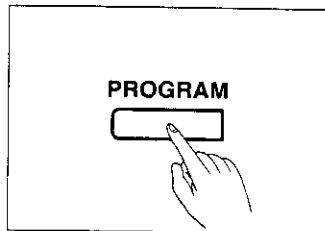

Press the **PROGRAM** button.

The display shows "P- ".

2

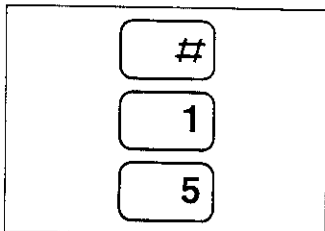

Press #, then press **15**.

The display shows "P-F15 0000".

3

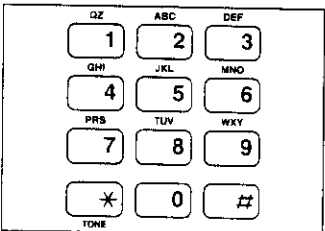

Enter your polling password of 4 digits by using the dial keypad.

4

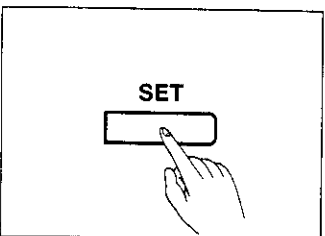

Press the **SET** button to store the program into memory.

The display shows "P- ".

5

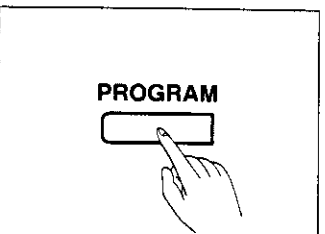

Press the **PROGRAM** button to end the operation.

Network Communication

The main passcode network communication feature eliminates fax transmission to unauthorized parties, and helps to prevent reception from an unauthorized station.

This feature is effective to prevent "Junk mail" faxes since only those units with the same passcode can transmit to your unit.

When the network communication feature is used, the identical main passcode of 4 digits must be programmed on both sides of the line. The unit checks the passcode before transmitting or receiving a document.

The unit provides two types of passcode check modes. They are TX (transmission) passcode check mode and RX (reception) passcode check mode.

■ TX Passcode Check:

Use this feature to restrict document transmission. If the passcode sent from the other Panasonic compatible machines does not match with the one programmed in your unit, transmission does not take place. (See page 4-10 for TX passcode check setting.)

■ RX Passcode Check:

Use this feature to restrict document reception. If the passcode sent from the other Panasonic compatible machines does not match with the one programmed in your unit, reception does not take place. (See page 4-11 for RX passcode check setting.)

NOTES:

- These features are effective only between Panasonic compatible machines that have the same passcode.
- The password for the polling feature is not related to this network communication feature. They are independent features.

Using a passcode

Before communication begins, check that your passcode and the other station's passcode are identical.

■ **When you want to transmit a document to a designated station only:**

Set TX PASSCODE CHECK to ON.

Function	Your unit	Other Panasonic compatible machine
TX PASSCODE CHECK	ON	ON/OFF
RX PASSCODE CHECK	OFF	ON/OFF

Your unit transmits a document only when the correct passcode has been received.

■ **When you want to receive a document from a designated station only:**

Set RX PASSCODE CHECK to ON.

Function	Your unit	Other Panasonic compatible machine
TX PASSCODE CHECK	OFF	ON/OFF
RX PASSCODE CHECK	ON	ON/OFF

Your unit receives a document only when the correct passcode has been received.

■ **When you want to have facsimile communications within a designated group of people:**

All the people in the group must set both TX PASSCODE CHECK and RX PASSCODE CHECK to ON.

Function	Your unit	Other Panasonic compatible machine
TX PASSCODE CHECK	ON	ON
RX PASSCODE CHECK	ON	ON

Only units that share identical passcodes can transmit and receive documents with each other.

Programming the main passcode

To activate this feature, the identical main passcode must be preprogrammed both on your unit and the other Panasonic compatible machine(s).

The main passcode may be any 4-digit number except 0000.

1

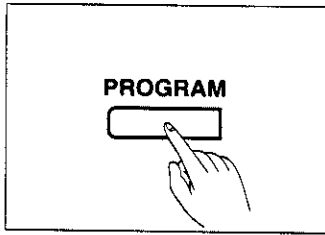

Press the **PROGRAM** button.

The display shows "P- ".

2

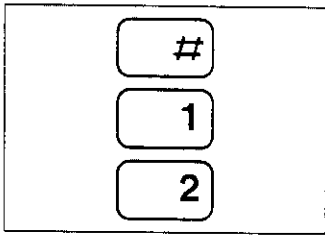

Press #, then press 12.

The display shows "P-F12 0000".

3

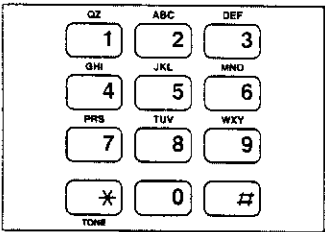

Enter the desired passcode of 4 digits using the dial keypad.

4

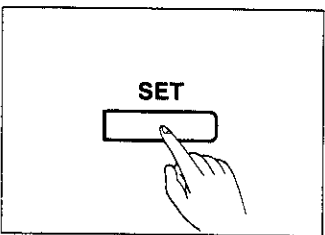

Press the **SET** button to store the program into memory.

The display shows "P- ".

5

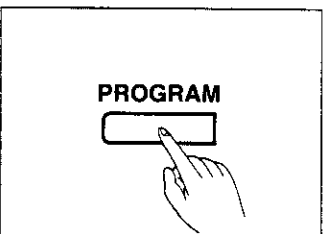

Press the **PROGRAM** button to end the operation.

Turning the TX passcode check on

1

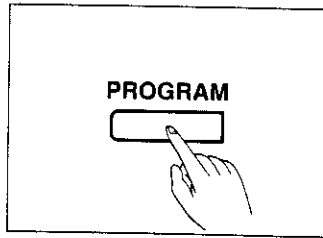

Press the **PROGRAM** button.

The display shows "P- ".

2

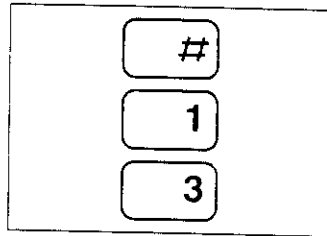

Press #, then press **13**.

The display shows "P-F13 2".

3

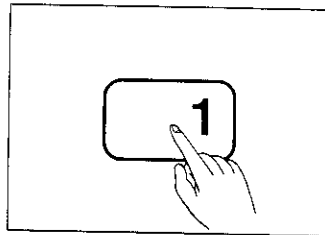

Press **1** to activate this feature.

Setting selections are:

- 1: ON (activate this feature)
- 2: OFF (deactivate this feature)

4

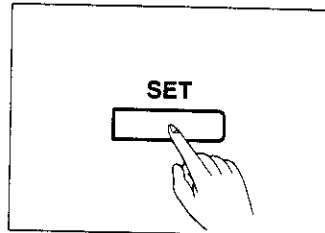

Press the **SET** button to store your selection into memory.

The display shows "P- ".

5

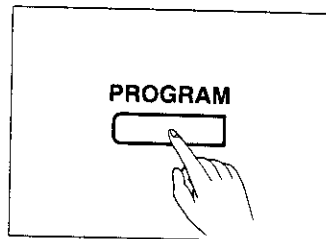

Press the **PROGRAM** button to end the operation.

NOTE:

If the network passcode is set to "0000", this feature does not work properly.

Turning the RX passcode check on

1

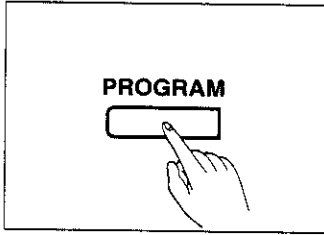

Press the **PROGRAM** button.

The display shows "P- ".

2

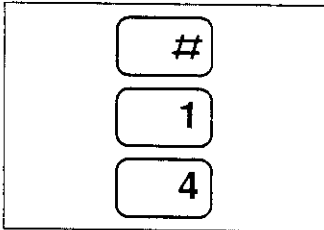

Press #, then press 14.

The display shows "P-F14 2".

3

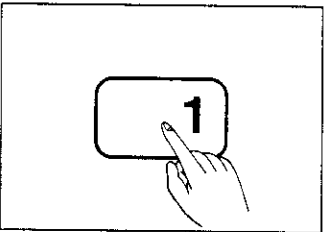

Press 1 to activate this feature.

Setting selections are:

1: ON (activate this feature)

2: OFF (deactivate this feature)

4

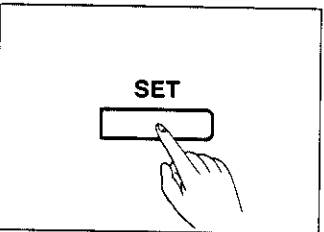

Press the **SET** button to store your selection into memory.

The display shows "P- ".

5

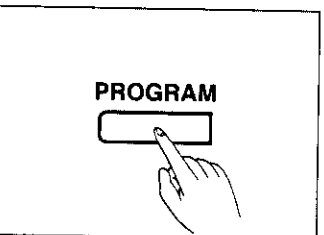

Press the **PROGRAM** button to end the operation.

NOTE:

If the network passcode is set to "0000", this feature does not work properly.

Remote Fax Receiving Using an Extension Phone

If you connect an extension to the same line to which your facsimile unit is connected, it is possible to receive a fax document into your facsimile unit by using the extension telephone near you. This saves you the trouble of going to the facsimile unit and pressing the START button.

NOTES:

- This feature is only effective when you receive a call.
- To activate this feature, use a touch tone telephone as an extension phone.

Using an extension phone

1

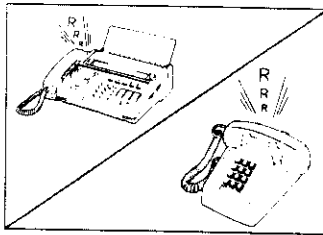

A call comes in.

2



Lift the handset of the extension phone.

3

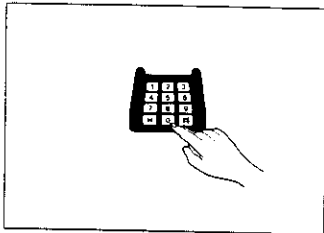

If a fax tone is heard, or the other party wishes to send you a fax, press * and * on the extension phone. Then replace the handset on the cradle.

4

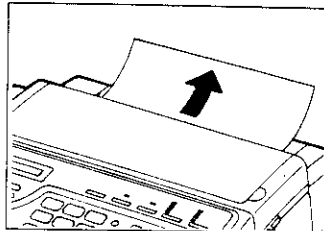

The unit will switch to the FAX mode, then receive a document.

NOTE:

Two *s can be changed to another 2 to 4-digit number. See page 4-13.

Programming a remote fax activation code

Your code can be from 2 to 4 digits long. The numbers 0 through 9 and characters # and * may be used. (e.g. **, 123, 123#)

1

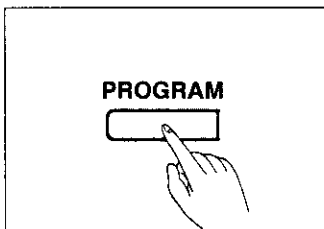

Press the **PROGRAM** button.

The display shows "P- ".

2

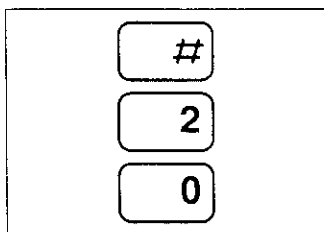

Press #, then press **20**.

The display shows "P-F20 4 4".

3

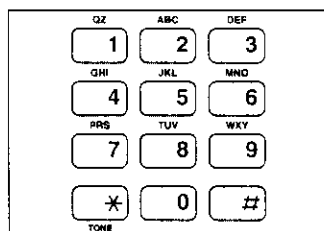

Enter the new code number using the dial keypad.

4

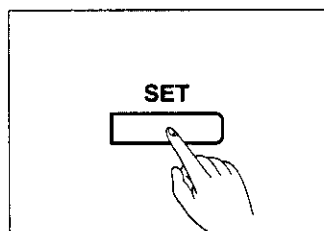

Press the **SET** button to store your program into memory.

The display shows "P- ".

5

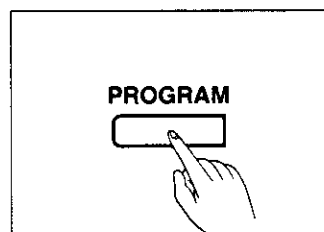

Press the **PROGRAM** button to end the operation.

NOTE:

"4" on the display indicates *. "E" on the display indicates "#".

Setting the Logo Print Position

Your logo, telephone number, date, time and page number will be printed on the transmitted document from your unit in the following condition.

OUT: Outside of the transmitted document's paper size (default).

IN: Inside of the transmitted document's paper size.

OFF: Not printed.

To change the logo position:

1

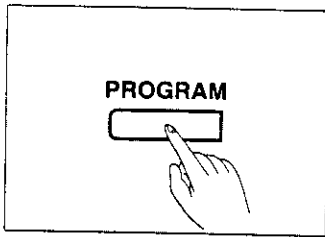

Press the **PROGRAM** button.

The display shows "P- ".

2

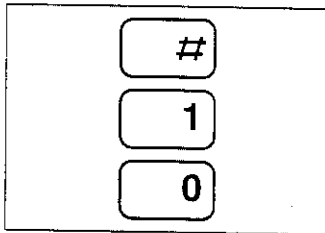

Press #, then press 10.

The display shows "P-F10 1".

3

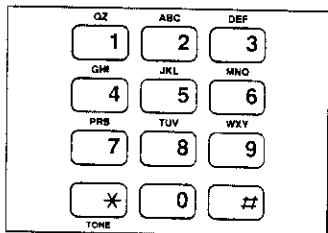

Press the number of the selection you desire.

Setting selections are:

1: OUT

2: IN

3: OFF

4

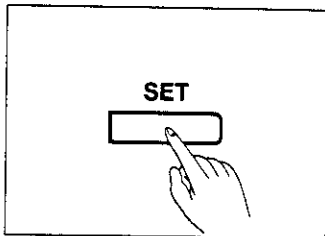

Press the **SET** button to store your selection.

The display shows "P- ".

5

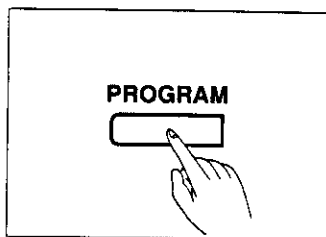

Press the **PROGRAM** button to end the operation.

Setting a Customized Header

A special message that is preprogrammed in your unit can be printed at the top of all pages transmitted.

You can choose the desired message among the following.

- A: CONFIDENTIAL
- B: URGENT REPLY REQUEST
- C: URGENT PLEASE READ

Sample page transmitted from your unit

Example: The message "CONFIDENTIAL" is printed.

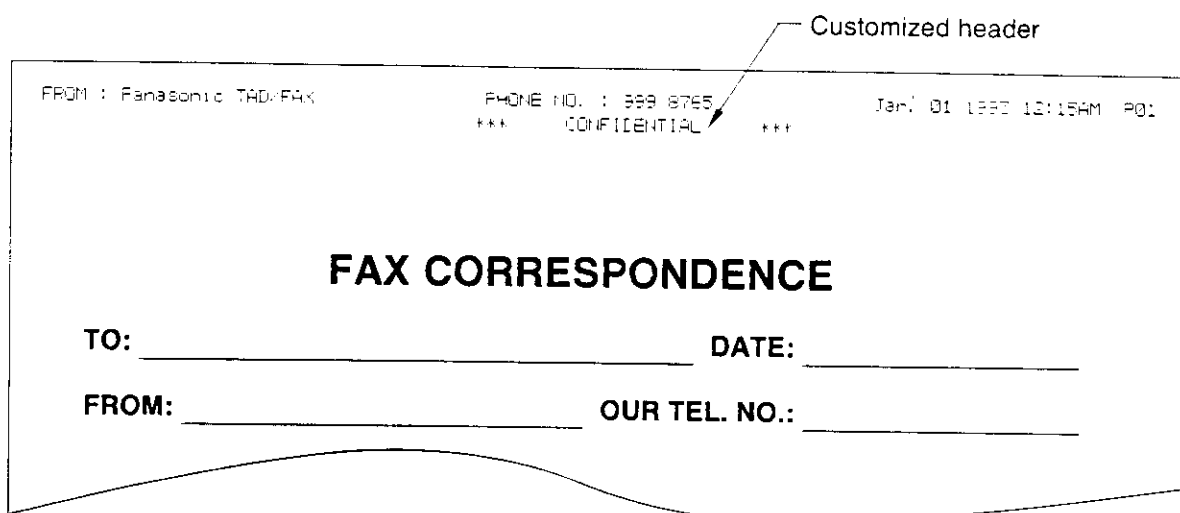

To set a special message:

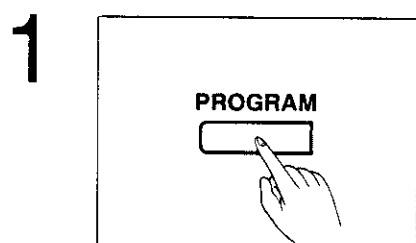

Press the **PROGRAM** button.

The display shows "P- ".

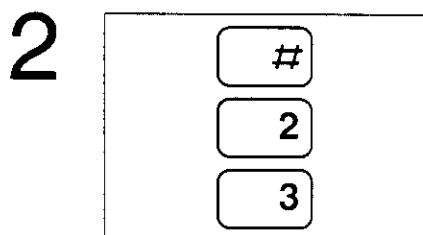

Press #, then press **23**.

The display shows "P-F23 4".

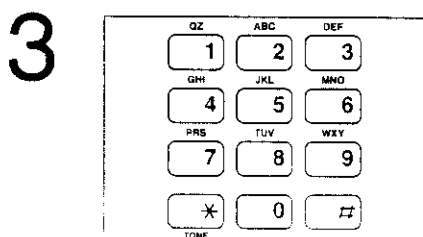

Select the number of the message you desire.

Setting selections are:

- 1: "CONFIDENTIAL" is printed.
- 2: "URGENT REPLY REQUEST" is printed.
- 3: "URGENT PLEASE READ" is printed.
- 4: OFF (deactivate this feature)

(continued)

4

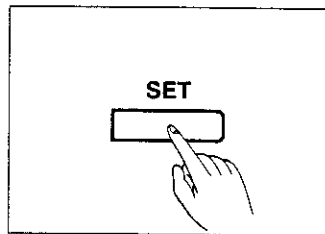

Press the **SET** button to store your selection into memory.

The display shows "P- ".

5

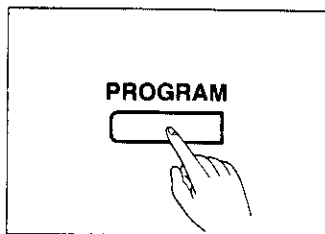

Press the **PROGRAM** button to end the operation.

NOTE:

This feature is automatically turned off after each transmission has been finished.

Setting the Paper Save Function

When this mode is set to on, the unit will reduce the data sent by the other party to a half in length when printing out. This mode also works in making a copy.

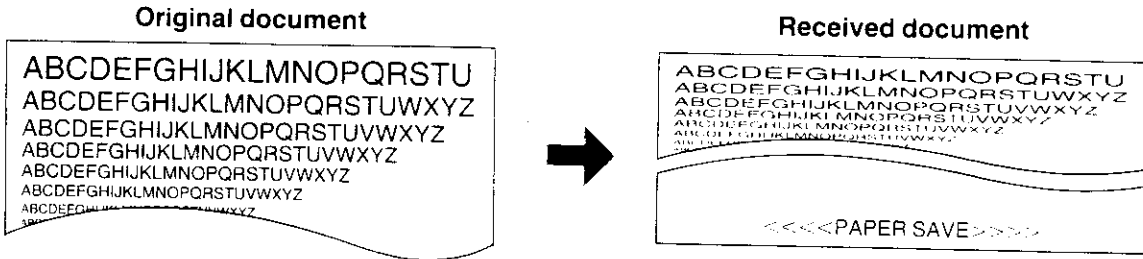

NOTE:

This feature does not work when the other party send documents in fine resolution or other nonstandard resolution, or when you make a copy using the FINE, SUPER FINE or HALF TONE resolution.

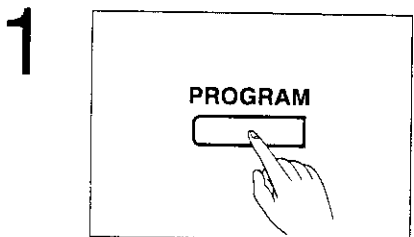

Press the **PROGRAM** button.

The display shows "P- ".

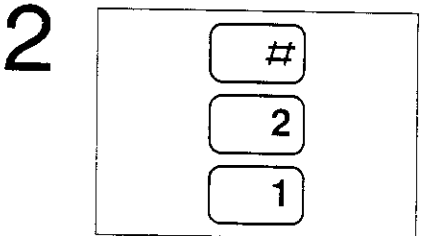

Press #, then press **21**.

The display shows "P-F21 2".

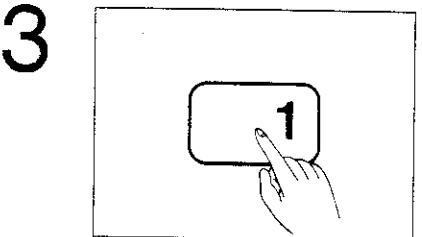

Press **1** to activate this function.

Setting selections are:

- 1: ON (activate this function)
- 2: OFF (deactivate this function)

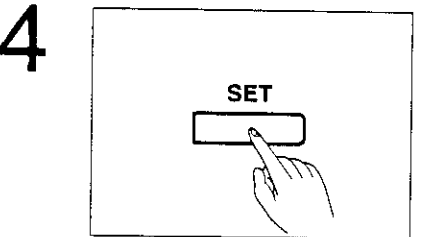

Press the **SET** button to store your selection into memory.

The display shows "P- ".

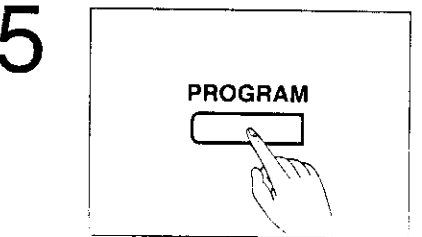

Press the **PROGRAM** button to end the operation.

Extension Copy

When this feature is set to on, the unit will copy a document twice in length. When it is hard to read a document sent by the other party with the Paper Save function on (see page 4-17) or for other reasons, we recommend that you use this feature.

Sample of copy:

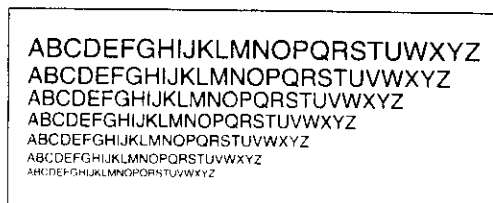

Extended copy:

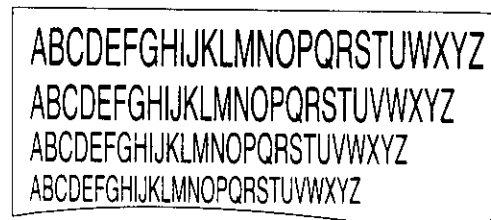

1

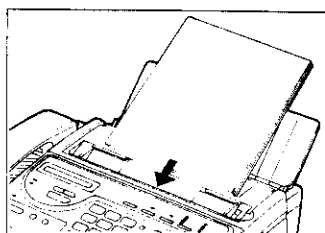

Insert the documents **FACE DOWN**.

The unit can accept up to 10 sheets of paper at a time.

2

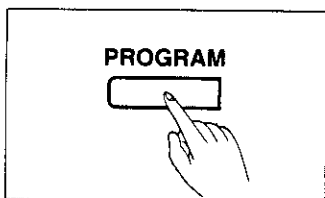

Press the **PROGRAM** button.

The display shows "P- ".

3

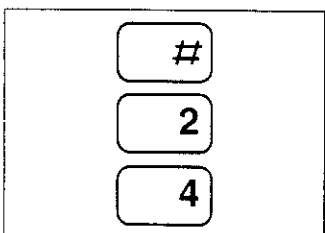

Press #, then press **24**.

The display shows "P-F24 ".

4

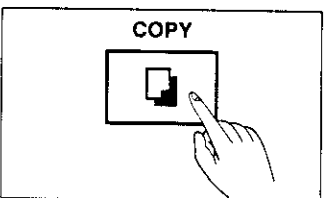

Press the **COPY** button.

The unit starts making a copy.

5

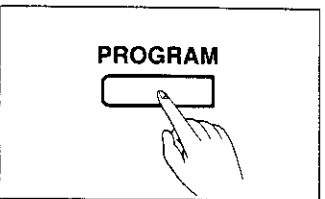

Press the **PROGRAM** button to end the operation.

The display shows the current time.

NOTES:

- This feature works even if the Paper Save function is on.
- To cancel an Extension Copy before pressing the COPY button, press the PROGRAM button or the STOP/CLEAR button twice.
To stop copying, press the STOP/CLEAR button.
- When copying documents printed on thermal recording paper, feed them into the unit one by one or they may jam.

Operating an Answering Device from a Remote Phone

While you are out, you can listen to any recorded incoming messages or re-record your greeting message using a touch tone telephone.

The following features are available on this unit:

- Playing back newly recorded messages
- Playing back all the recorded messages
- Back space and skip forward
- Recording a marker message
- Resetting the tape for future messages
- Re-recording the greeting message
- Skipping the greeting message for incoming message recording mode

Before using these features, you must program your unique remote code (REMOTE TAD ID) that lets you access the answering device of your unit.

The REMOTE TAD ID is preset to "111" as a default.

If you wish to change the code, see page 1-32.

Summary of remote control functions

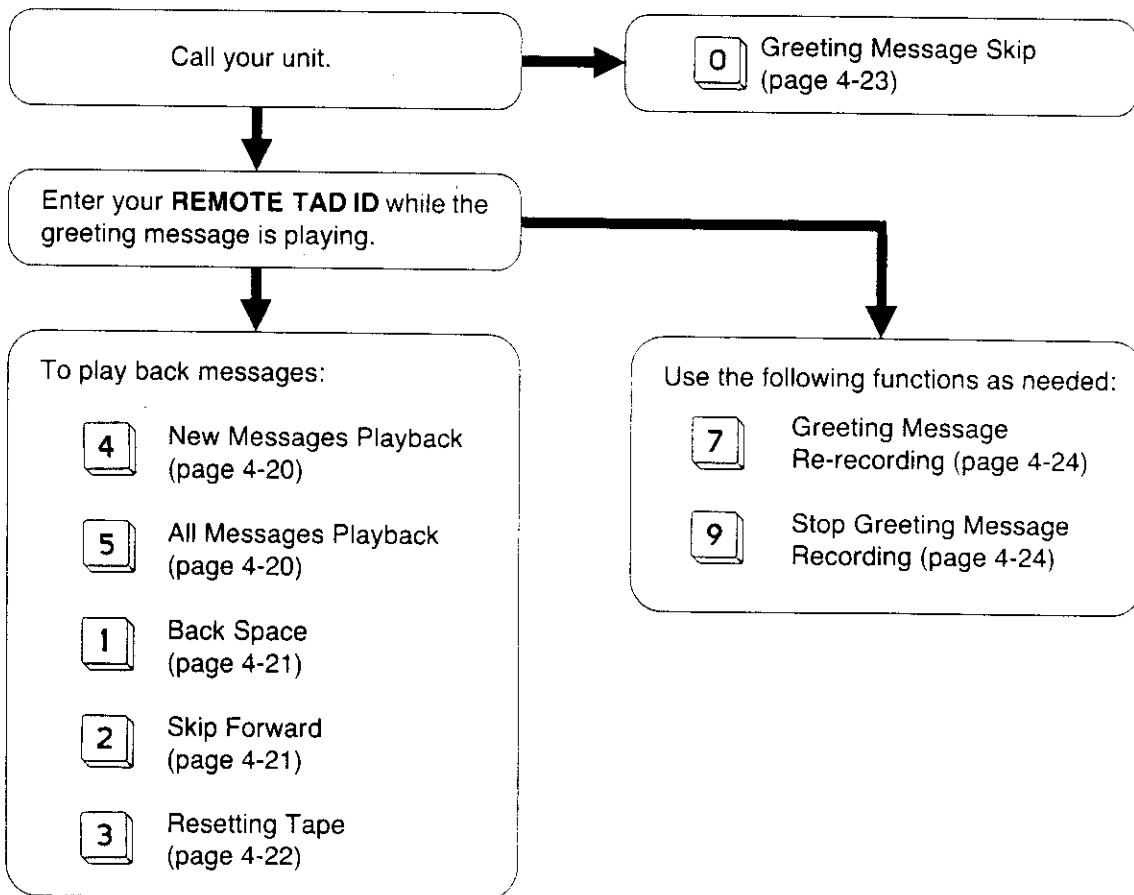

NOTE:

For your convenience, a quick reference card for remote operation is attached in these operating instructions. See pages 6-19 and 6-20.

Playing back newly recorded messages (Memory playback)

It is possible to skip over the recorded messages you have already heard and to play back only new messages.

1

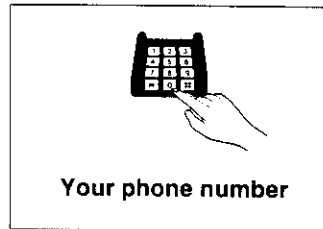

Call your unit.

2

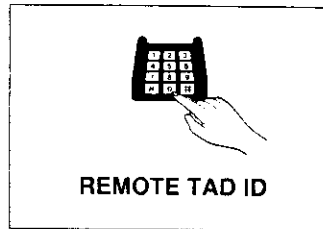

Dial your REMOTE TAD ID while the greeting message is playing.

A long beep and a short beep(s) will sound. Short beep(s) indicate(s) the number of recorded message(s) up to 8 times. Even if 9 or more calls are recorded, a short beep sounds 8 times.

3

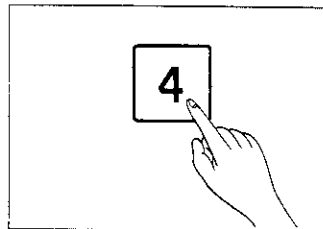

Press 4 immediately after hearing the beeps that indicate the number of recorded messages.

The unit plays back the new messages.

NOTE:

Even during the playback of previously heard messages, you can skip them by pressing 4.

Playing back all messages

You can listen to all the recorded messages from the beginning of the tape.

1

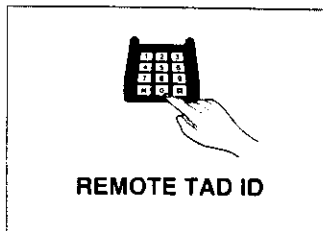

Call your unit then dial your REMOTE TAD ID while the greeting message is playing.

2

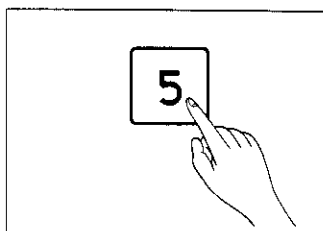

Press 5 within 4 seconds after the short beeps.

The unit will rewind the tape and start to play back all messages. At the end of the last message, 3 beeps will sound. After hanging up, all the recorded messages are saved and the unit is ready to record further messages.

NOTE:

Even if you do not press 5 in Step 2, playback of all messages starts automatically.

Back space and skip forward

While listening to the recorded messages, you can rewind or advance the tape.

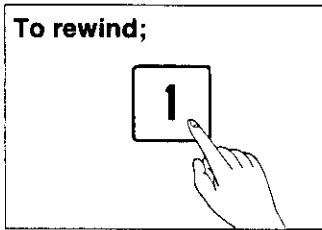

To rewind, press 1.

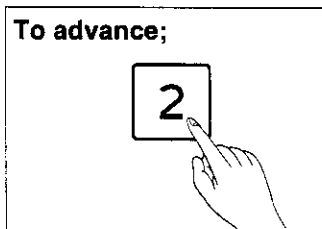

To advance, press 2.

NOTE:

The maximum length of a message that can be rewound or advanced by one press is approximately 15 seconds. You may have to press 1 or 2 several times to rewind or advance the tape to the desired position.

Recording a marker message

After playing back the recorded messages, you can leave an additional message during the same call. When playback is finished, wait for 3 beeps indicating the end of the last message. Wait about 10 seconds for another 2 beeps indicating that the tape is ready for recording.

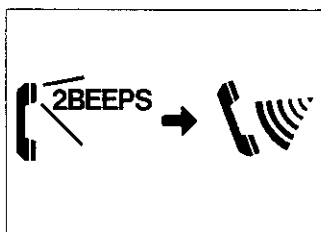
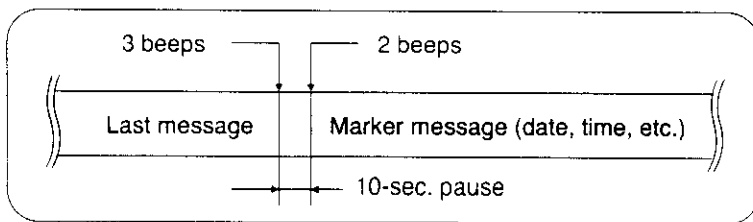

Leave your message after the last 2 beeps.

Hang up when finished. The marker message is recorded after the last message on the tape.

Resetting the tape for future messages

After listening to the recorded messages, you can reset the tape to record future messages from the beginning of the tape.

After all the messages have been played back or even while they are being played;

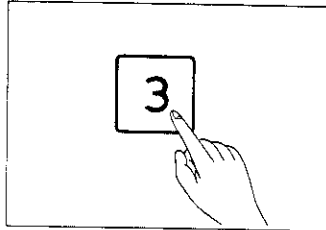

Press **3**, then hang up.

The unit rewinds the tape to the beginning. Future messages will be recorded and the previously recorded messages are erased.

If you have used New Messages Playback;

1

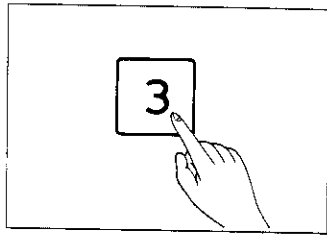

Press **3**.

The unit rewinds the tape to the beginning of the newly recorded messages, then beeps.

2

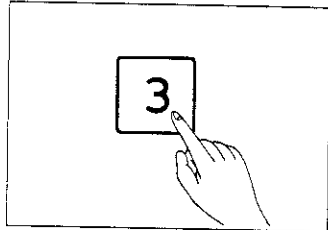

Press **3** again after hearing the beep.

The unit rewinds the tape to the beginning of the previously recorded messages.

If you have reset the tape by mistake;

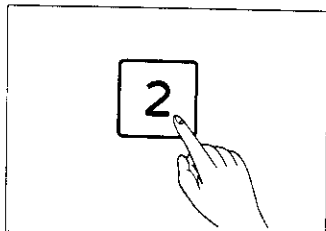

Press **2** after the tape has been reset.

One beep sounds.

The unit advances the tape to the end of the recorded messages.

Skipping the greeting message for incoming message recording mode

Callers can leave a message on your unit without listening to your greeting message.

1

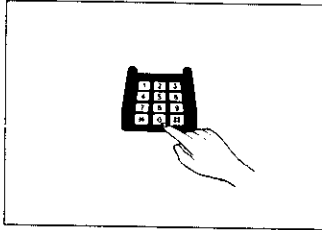

Call your unit.

2

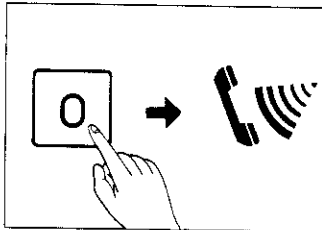

Press **0** while the greeting message is playing.

After hearing a long beep, speak clearly and loudly to leave a message.

Re-recording a greeting message

You can change the content of your greeting message from a remote telephone.

1

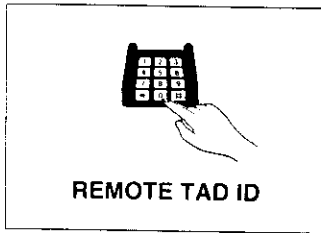

Call your unit, then dial your REMOTE TAD ID when the greeting message is playing.

2

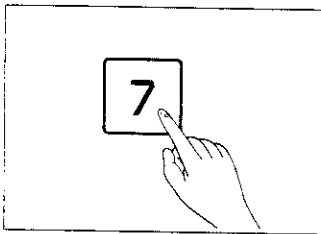

Press 7 to start re-recording after hearing the beep that indicates the number of recorded messages.

3

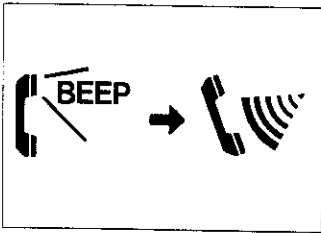

After hearing a long beep, speak clearly and loud up to 16 seconds.

4

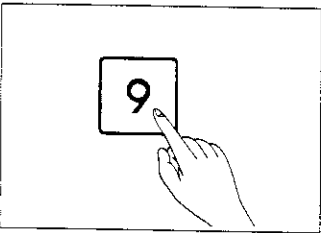

When finished, press 9.

The new greeting message is played to confirm the change.

NOTE:

If you pause for over 2 seconds while recording, the unit beeps and stops the greeting message recording. In this case, repeat from Step 2 within 10 seconds.

Call with Privacy Ring

This feature eliminates interruptions caused by unwanted calls. Only callers with a passcode can activate a distinctive tone during the playing of your greeting message to notify you of a priority call.

Entering a unique 3-digit code activates this feature. Issue your code to those callers with priority status. All other calls will be routed to the answering system unless you pick up the handset.

The unit provides PRIVACY RING ID "333" as default setting. If you want to change the number, you can choose any number of 3 digits except numbers including "0". You should also use a number that is different from the REMOTE TAD ID (see page 1-32).

Programming the PRIVACY RING ID

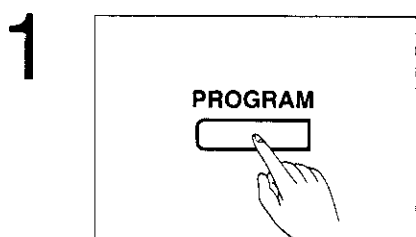

Press the **PROGRAM** button.

The display shows "P- ".

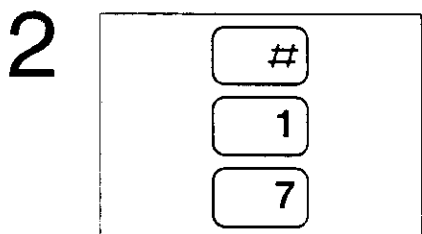

Press #, then press 17.

The display shows "P-F17 333".

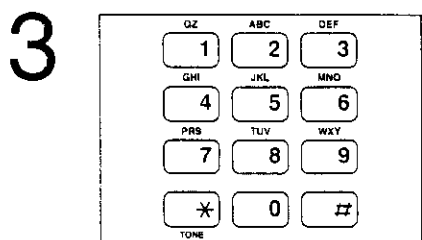

Enter the 3-digit number as the new PRIVACY RING ID.

To correct an error, press the STOP/CLEAR button then correct input.

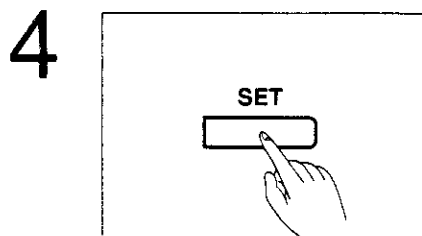

Press the **SET** button to store the program into memory.

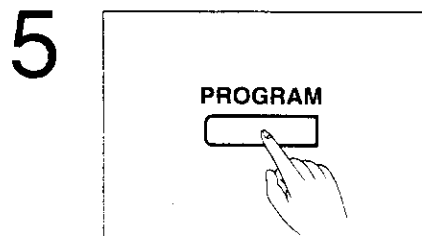

Press the **PROGRAM** button to end the operation.

Calling with the privacy ring

Instructions for caller:

1

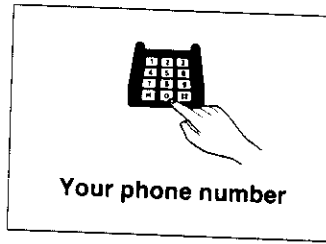

Call the unit with a touch tone telephone.

2

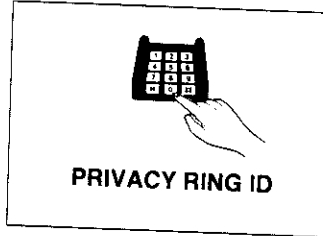

Enter the PRIVACY RING ID during the greeting message or the incoming message recording mode.

NOTES:

- If nobody answers, press 0 to turn on the incoming message recording mode.
- The unit rings with a distinctive tone for 30 seconds and goes to the incoming message recording mode if nobody answers. To repeat this process, enter the PRIVACY RING ID again during the incoming message recording mode.

Setting the Message Alert

When this feature is on, the unit will let you know with an alert if a caller's message has been recorded in the unit or not.

When a new message is recorded in the ANS/FAX mode, a slow beep will sound and the **CB** indicator will blink. When you hear the beep sound, play back the message(s), the beep sound will stop and the indicator will stop blinking.

To set the message alert:

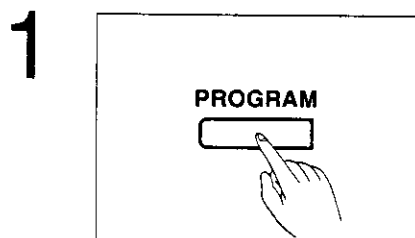

Press the **PROGRAM** button.

The display shows "P- ".

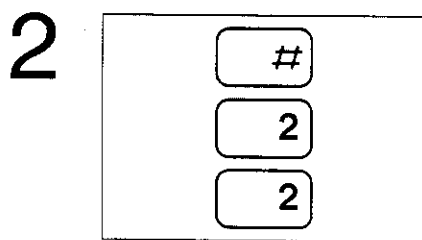

Press #, then press **22**.

The display shows "P-F22 2".

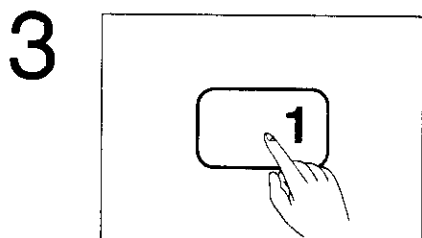

Press **1** to activate this feature.

Setting selections are:

- 1: ON (activate this feature)
- 2: OFF (deactivate this feature)

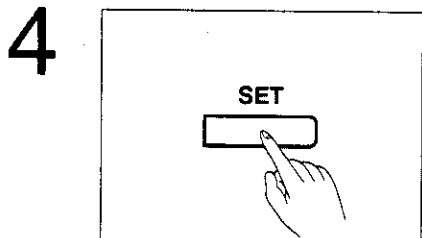

Press the **SET** button to store your selection into memory.

The display shows "P- ".

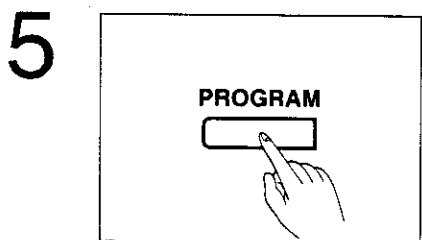

Press the **PROGRAM** button to end the operation.

Voice Contact

Initiating voice contact

While transmitting or receiving a document, you may wish to speak to the other party. If your party's unit is equipped with a voice contact feature, you can initiate voice contact and notify the other party that you wish to speak after the transmission/reception is completed. The other party's fax will emit a distinctive ring that indicates that a voice conversation is required. This saves the expense and time of making a subsequent telephone call to discuss information sent over the fax.

1

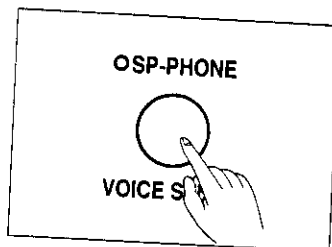

Press the **SP-PHONE** button or lift the handset while transmitting or receiving the documents.

2



When the other party answers, start speaking into the handset or the speaker-phone.

—If you initiate voice contact while transmitting documents, you can speak after all the documents have been transmitted.

—If you initiate voice contact while receiving documents, you can speak after receiving the last page of the documents.

Receiving a request for voice contact

If the other party initiates voice contact during transmission or reception, your unit will emit a distinctive ring after the fax is completed.



When the unit rings, lift the handset or press the **SP-PHONE** button, then start speaking.

NOTE:

If you do not answer within 10 seconds after hearing several rings indicating the request for voice contact, one of the following occurs:

- When the unit is in the ANS/FAX mode, it plays back your greeting message and records your voice-message on the tape.
- When the unit is in the TEL/FAX mode, the line is disconnected.
- When the unit is in the FAX mode, the line is disconnected.
- When the unit is in the TEL mode, the line is disconnected.

TONE, RECALL and PAUSE Button Usage

TONE button (Temporary tone dialing)

This function is only used when your line has a rotary pulse dial service. Pressing the TONE (*) button allows you to change from pulse to tone mode during a dialing operation, and enter special tones and codes to operate the answering device, electronic banking services, call processing services and other special services.

Using the TONE button:

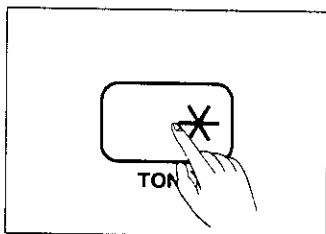

Press the **TONE (*)** button.

When you hang up, the unit automatically returns to pulse mode.

NOTES:

- Store "TONE" in memory as explained on pages 3-2 to 3-5.
- Pressing the TONE button counts as 1 digit while programming.

RECALL button

The RECALL button is used to access some of the features of your host PABX (Private Automatic Branch Exchange).

For further details, please contact your local telephone company for information about the availability of these services in your area.

Using the RECALL button:

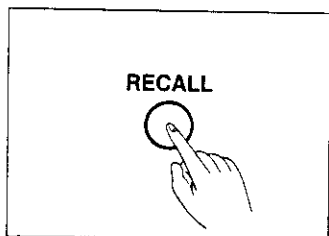

Press the **RECALL** button briefly when required.

NOTES:

- Store "RECALL" in memory as explained on pages 3-2 to 3-5.
- Pressing the RECALL button counts as 1 digit while programming.

PAUSE button

The PAUSE button is used in a dial sequence to access an outside line. Pressing the PAUSE button creates a dialing delay.

Using the PAUSE button:

Example: Line access number 9

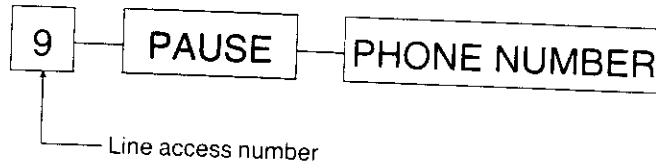

NOTES:

- Store "PAUSE" in memory as explained on pages 3-2 to 3-5.
- Pressing the PAUSE button counts as 1 digit while programming.

Combination dialing

The following combination of dialing methods can be used.

- Manual dialing and automatic dialing
- Pulse and Tone dialing
- Plural memory stations

Other Features

Setting Day/Night Mode

You may wish to use the unit as a telephone and facsimile during the business hours and switch to the answering device during off hours.

With this feature on, the unit automatically switches from TEL/FAX mode (Day mode) to ANS/FAX mode (Night mode) at a preprogrammed time without the operator's assistance.

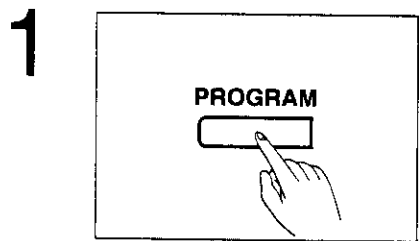

Press the **PROGRAM** button.

The display shows "P- ".

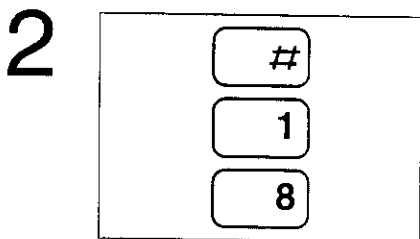

Press #, then press 18.

The display shows "P-F18 2".

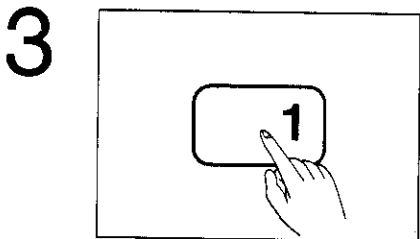

Press 1 to turn on the Day/Night Mode.

Setting selections are:

- 1: ON (activate this feature)
- 2: OFF (deactivate this feature)

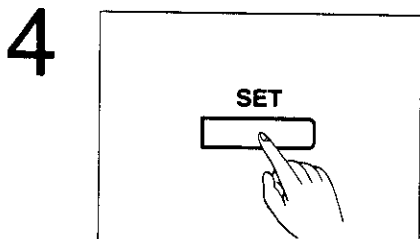

Press the **SET** button.

The display shows "AM P-F18 12-00".

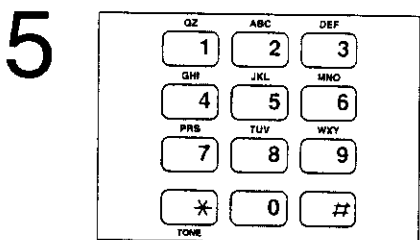

Enter the time at which the TEL/FAX mode (Day mode) starts.

Example: The TEL/FAX mode start time is 8:00AM.
Press 08 and 00.
AM or PM is alternately selected by pressing*.
The display shows "AM P-F18 08-00".

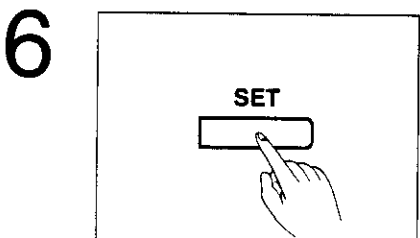

Press the **SET** button.

The display shows "AM P-F18 12-00".

(continued)

7

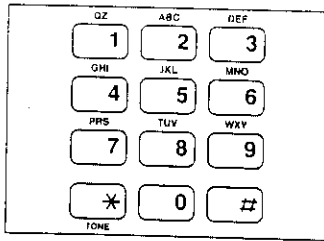

Enter the time at which the unit switches to the ANS/FAX mode (Night mode).

Example: The ANS/FAX mode start time is 5:00PM
Press 05 and 00.
AM or PM is alternately selected by press *.

8

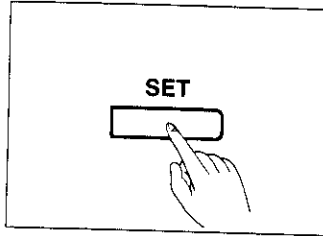

Press the **SET** button.

The display shows "P- ".

9

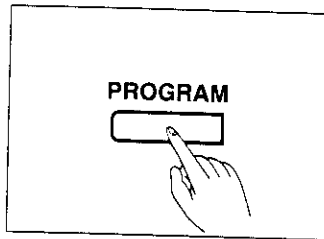

Press the **PROGRAM** button to end the operation.

NOTE:

If you select another receiving mode manually while this feature is on, the unit keeps the receiving mode that you selected until the Day or Night mode starts.

Setting the Silent Fax Recognition Ring

When a voice call is received in the TEL/FAX mode, the unit will ring three times before it switches automatically to the fax. When an automatic fax transmission is received in the TEL/FAX mode, the unit will receive the fax without ringing (we call this "Silent Fax Recognition Ring"). Change the number of rings choosing the number among "3" (three rings) through "8" (eight rings). The three rings is preset as default.

NOTES:

- This feature is effective only in the TEL/FAX mode.
- Telephone fees are charged to the calling party from the first ring.

To change the ring count:

1

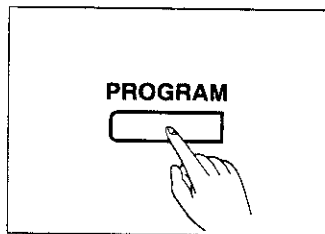

Press the **PROGRAM** button.

The display shows "P- ".

2

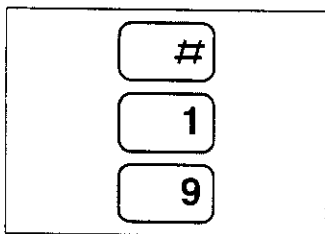

Press #, then press **19**.

The display shows "P-F19 3".

3

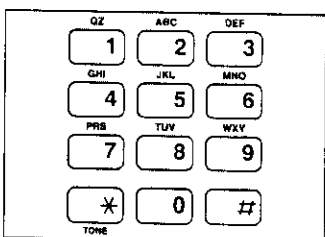

Enter the desired number from 3 to 8.

4

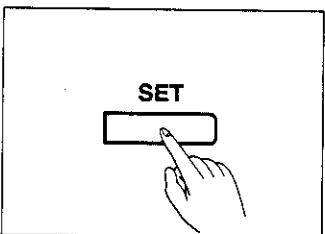

Press the **SET** button to store your selection into memory.

The display shows "P- ".

5

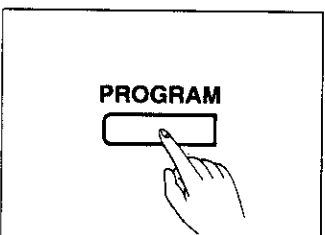

Press the **PROGRAM** button to end the operation.

Setting the Recall Mode

Depending on your host PBX, set the mode to T-BR or E-RE.
For further details, please consult with your service center.

T-BR: Select this mode if the PBX requires T-BR. (Default)

E-RE: Select this mode if the PBX requires E-RE.

To change the recall mode, proceed as follows.

1

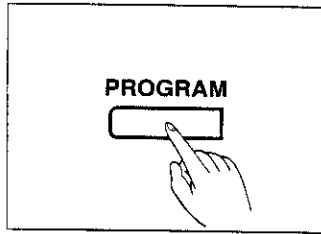

Press the **PROGRAM** button.

The display shows "P-".

2

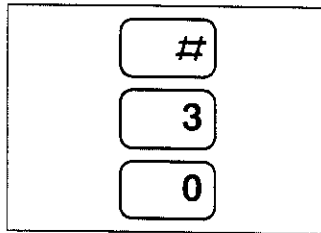

Press #, then press **30**.

The display shows "P-F30 1".

3

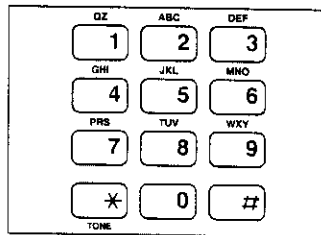

Press the number of the recall mode you wish to set.

Setting selections are:

1: T-BR

2: E-RE

4

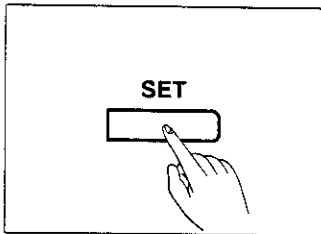

Press the **SET** button to store your selection into memory.

The display shows "P-".

5

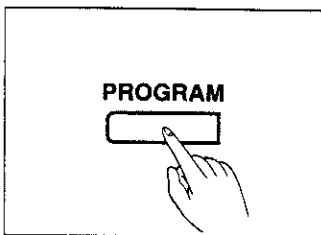

Press the **PROGRAM** button to end the operation.

The display shows the current time.

Resetting the setup features

Use this operation to return the advanced features of #10 through #23 and #30 (see page 1-18) to their initial default settings.

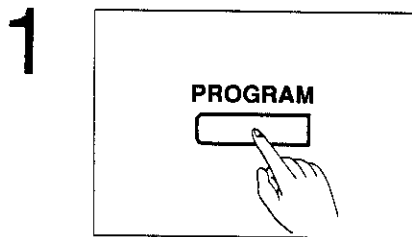

Press the **PROGRAM** button.

The display shows "P- ".

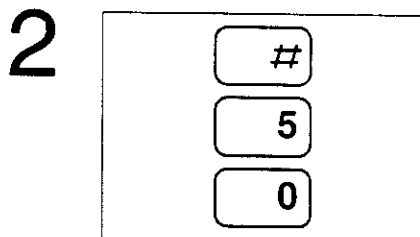

Press #, then press 50.

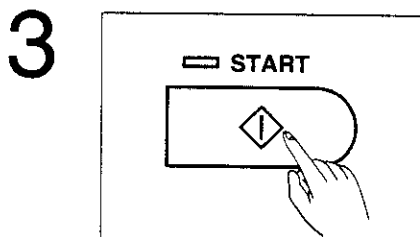

Press the **START** button.

The following message will be printed out.

USER PROGRAMMABLE FUNCTIONS RESET OK? YES: PRESS "START"
 NO : PRESS "STOP/CLEAR"

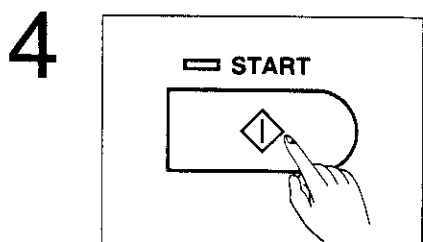

Press the **START** button to return to initial settings.

The following message will be printed out.

USER PROGRAMMABLE FUNCTIONS RESET COMPLETED

OR

Press the **STOP/CLEAR** button to cancel.

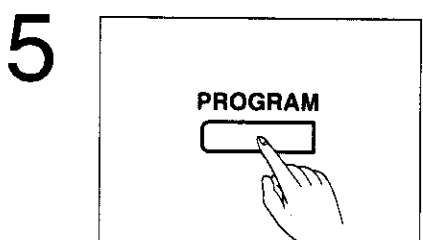

Press the **PROGRAM** button to end the operation.

Advanced Instructions

Chapter 5

Printing Reports and Lists

Table of contents

Activity Report (JOURNAL Report)	5-2
Setting the JOURNAL AUTO PRINT	5-3
Printing a JOURNAL report manually	5-4
List of Stored Phone Numbers (TELEPHONE NUMBER LIST)	5-5
Printing a TELEPHONE NUMBER LIST	5-6
Basic Feature List	5-7
Advanced Feature List	5-8

When the display shows "E-XX",
see page 6-2 for corrective measures.

Activity Report (JOURNAL Report)

You can obtain a record of the last 20 transactions (transmissions and receptions) automatically or manually.

When the JOURNAL AUTO PRINT is set to **AUTO**, the report prints automatically after every 20 transactions. After each 20 transactions, the report clears and the list begins again. It may also be printed on request.

When you set this feature to **MANUAL**, the JOURNAL report data is stored until the memory becomes full. Once the memory is full, the oldest entry in the memory is deleted when a new transaction takes place.

This feature has been preset to **AUTO** as the default.

These reports are useful for keeping records of telephone usage or verifying telephone long distance charges.

Printing Reports and Lists

Print time: Hour/Minute AM/PM
Print date: Month/Day/Year

Jan. 02 1990 10:56AM

```
***** JOURNAL *****
```

NO.	OTHER FACSIMILE	START TIME	USAGE TIME	MODE	PAGES	RESULT	CODE
* 01	1234567	Jan. 1 11:38AM	01'30	T	02	OK	(00)
* 02	9996785	Jan. 1 11:52AM	00'58	T	01	OK	(00)
* 03	XXXX 03	Jan. 1 11:38AM	00'32	R	01	OK	(00)
* 04	5556677	Jan. 1 12:19PM	01'48	T	03	OK	(00)
* 05	+997 1234	Jan. 1 12:35PM	01'45	R	03	OK	(00)
* 06	(501)	Jan. 1 1:14PM	02'40	T	05	OK	(00)
* 07	7776543	Jan. 1 1:27PM	01'03	T	01	OK	(00)
* 08	4445566	Jan. 1 2:46PM	01'18	T	02	OK	(00)
* 09	(A27)	Jan. 1 3:17PM	00'05	T	00	PRESSED THE STOP KEY	(A2)
* 10	XXXX 03	Jan. 1 3:19PM	01'21	R	02	OK	(00)
* 11	661234	Jan. 1 3:39PM	02'35	T	04	OK	(00)
* 12	(808)	Jan. 1 4:20PM	01'02	T	01	OK	(00)
* 13	+1173		02'18	T	04	OK	(00)
* 14							
* 15	03	Jan. 2 9:40AM					
* 16	5556677	Jan. 2 10:36AM	01'02				(00)
* 17							
* 18	9996675	Jan. 2 10:55AM	00'58	T	01	OK	(00)
* 19							
* 20							

Communication number (up to 20)

Communication start time

Length of communication:
Minutes/Seconds

Transaction mode:
TX...Transmission
RX...Reception
POL.RX...Polling

Number of pages received or transmitted successfully

Communication result

Error code:
(for the service center only)

Explanation of communication result

- OK: Successful communication
- PRESSED THE STOP KEY: The fax communication was interrupted since the STOP/CLEAR button was pressed.
- DOCUMENT JAMMED: A document jammed.
- NO DOCUMENT: The document was not fed into the unit properly.
- PRINTER OVERHEATED: Printing head was overheated.
- PAPER OUT: The unit is out of recording paper.
- THE COVER WAS OPENED: The front lid or back lid was opened.
- COMMUNICATION ERROR: Transmission or reception error.
- PASSCODE FAILED: Passcode communication failed.
- NO RESPONSE: Receiving unit is busy or out of recording paper.
- PAPER JAMMED: The recording paper was jammed.

Setting the JOURNAL AUTO PRINT

1

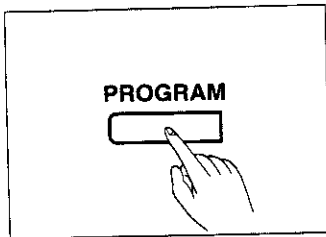

Press the **PROGRAM** button.

The display shows "P- ".

2

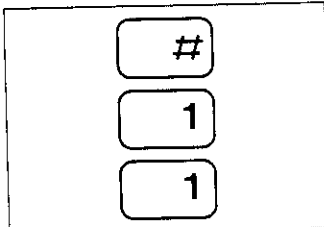

Press #, then press 11.

The display shows "P-F11 1".

3

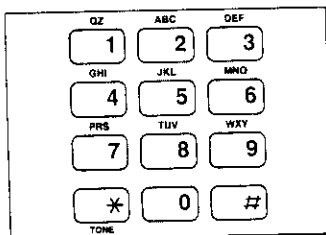

Press the number of the selection you desire.

Setting selections are:

1: AUTO (Prints a report every 20 transactions automatically.)

2: MANUAL

4

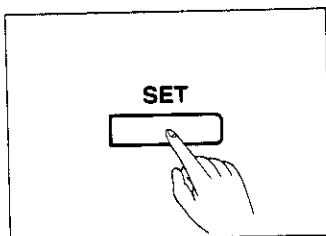

Press the **SET** button to store your selection into memory.

The display shows "P- ".

5

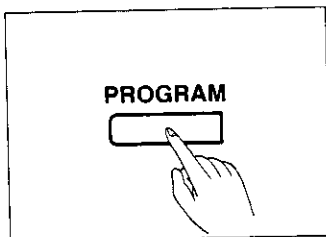

Press the **PROGRAM** button to end the operation.

Printing a JOURNAL report manually

You can print a report of the current JOURNAL upon request. This will not clear the report which will continue until 20 transactions are completed.

1

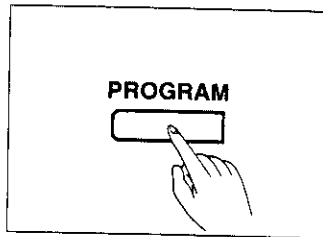

Press the **PROGRAM** button.

The display shows "P- ".

2

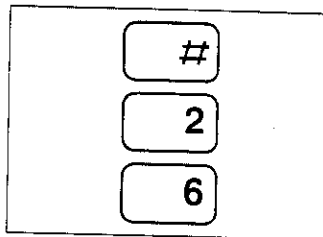

Press #, then press **26**.

The display shows "P-F26".

3

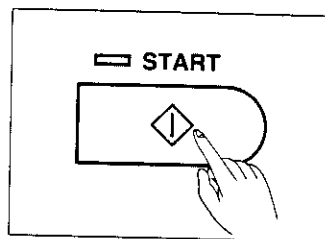

Press the **START** button to obtain a report.

The unit will start printing.

If there have been no transactions, no JOURNAL is printed.

When finished, the display shows the current time.

List of Stored Phone Numbers (TELEPHONE NUMBER LIST)

You can print a list of the numbers programmed for one touch dialing and speed dialing. Use this feature to confirm that you have correctly stored phone numbers.

Sample of TELEPHONE NUMBER LIST

```

***** TELEPHONE NUMBER LIST *****
*
*                               << STATION KEY LIST >>                               *
*-----*-----*-----*-----*-----*-----*-----*-----*-----*-----*
*      PHONE NUMBER                PHONE NUMBER                                *
*      01 T092-123-4567             07 R999-1234                             *
*      02 T83R555-1234             08 R(          )                          *
*      03 T012-999-8877             09                                     *
*      04 T83R4567                  10                                     *
*      05 T987-6543                 11                                     *
*      06                            12                                     *
*
*                               << AUTO KEY LIST >>                               *
*-----*-----*-----*-----*-----*-----*-----*-----*-----*-----*
*      PHONE NUMBER                PHONE NUMBER                                *
*      00 T111-2233                 14 T222-3344                             *
*      01 R765-4321                 15 T9P092-555-6677                       *
*      02 T345F6789                 16                                     *
*      03 R092(          ) 1         17                                     *
*      04                            18                                     *
*      05                            19                                     *
*      06                            20                                     *
*      07                            21 Secret phone number                *
*      08                            22                                     *
*      09                            23                                     *
*      10                            24                                     *
*      11                            25                                     *
*      12                            26                                     *
*      13                            27                                     *
*
*****

```

Printing Reports and Lists

Codes in each phone number:

- T: Shows that you have entered the telephone number in the TONE dialing mode.
- R: Shows that you have entered the telephone number in the PULSE (rotary) dialing mode.
- P: Shows that you have entered PAUSE.
- F: Shows that you have entered RECALL.

Printing a TELEPHONE NUMBER LIST

1

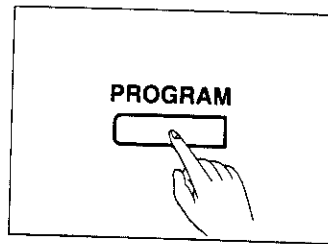

Press the **PROGRAM** button.

The display shows "P- ".

2

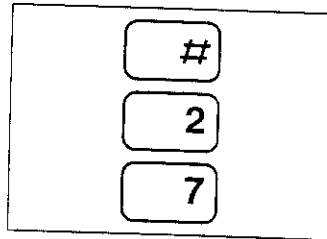

Press #, then press 27.

The display shows "P-F27".

3

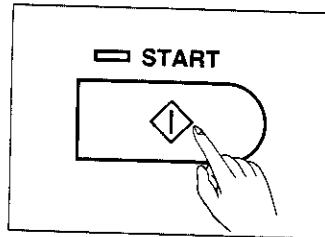

Press the **START** button.

The unit will start printing.

When finished, the display shows the current time.

Basic Feature List

Sample of Basic Feature List

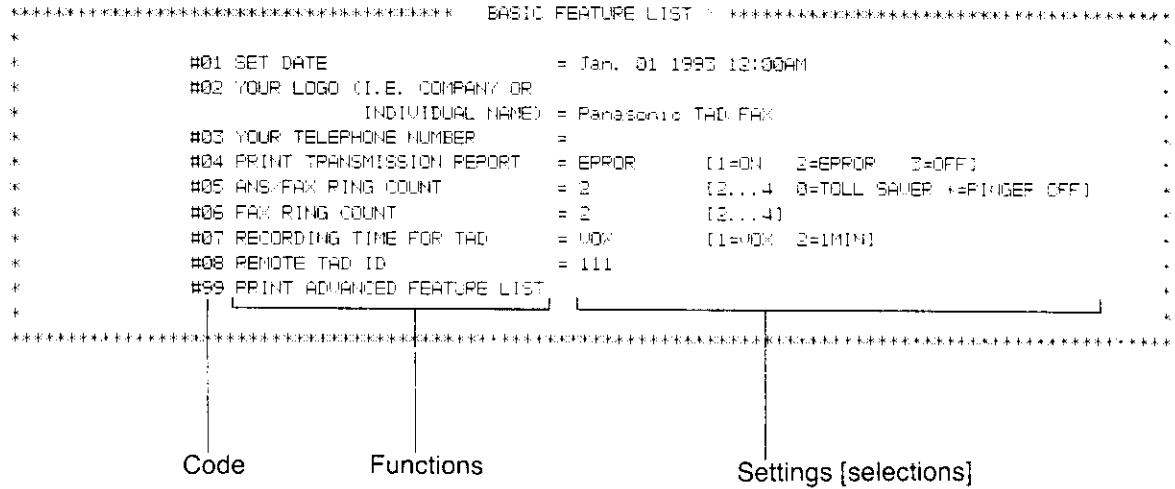

Printing Reports and Lists

To obtain Basic Feature List:

1

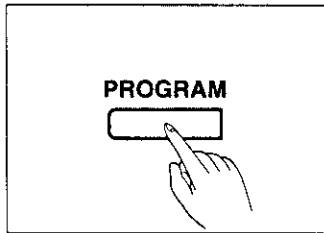

Press the **PROGRAM** button.

The display shows "P- ".

2

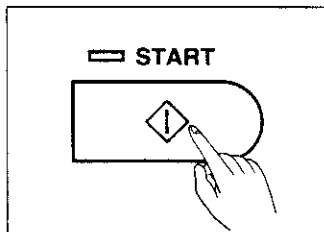

Press the **START** button.

The unit will start printing.
When finished, the display shows the current time.

Advanced Feature List

Sample of Advanced Feature List

Code	Functions	Settings (selections)
***** < ADVANCED FEATURE LIST > *****		
#10	LOGO POSITION	= OUT [1=OUT 2=IN 3=OFF]
#11	JOURNAL AUTO PRINT	= AUTO [1=AUTO 2=MANUAL]
#12	MAIN PASSCODE	= 0000
#13	TX PASSCODE CHECK	= OFF [1=ON 2=OFF]
#14	RX PASSCODE CHECK	= OFF [1=ON 2=OFF]
#15	POLLING PASSWORD	= 0000
#16	DELAYED TRANSMISSION	= OFF [1=ON 2=OFF]
	START TIME	= 12:00AM
	DESTINATION	=
#17	PRIVACY RING ID	= 333
#18	DAY/NIGHT MODE	= OFF [1=ON 2=OFF]
	DAY TIME	= 12:00AM
	NIGHT TIME	= 12:00AM
#19	SILENT FAX RECOGNITION RING	= 3 [3...8]
#20	REMOTE FAX ACTIVATION CODE	= **
#21	PAPER SAVE FUNCTION	= OFF [1=ON 2=OFF]
#22	MESSAGE ALERT	= OFF [1=ON 2=OFF]
#23	CUSTOMIZED HEADER	= OFF [1=A 2=B 3=C 4=OFF]
	A= *** CONFIDENTIAL ***	
	B= *** URGENT REPLY REQUEST ***	
	C= *** URGENT PLEASE READ ***	
#24	EXTENSION COPY	
#26	PRINT JOURNAL	
#27	PRINT TEL LIST	
#28	PRINTER TEST	
#30	RECALL MODE	= T_LBR [1=T_LBR 2=E_LRE]
#50	SET DEFAULT (#10 TO #30)	
#9000*	(SERVICE DATA SET UP)	← This code is only for a service center.

Printing Reports and Lists

To obtain an Advanced Feature List:

1

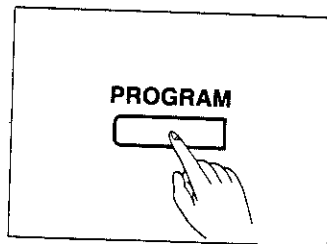

Press the **PROGRAM** button.

The display shows "P- ".

2

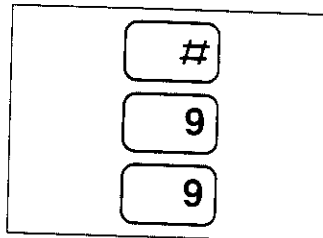

Press #, then press **99**.

3

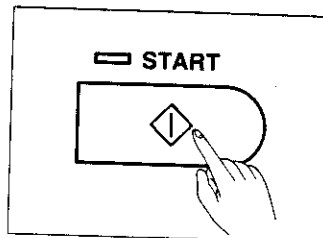

Press the **START** button.

The unit will start printing.

When finished, the display shows the current time.

Chapter 6

General Information

Table of contents

Troubleshooting	6-2
Error code	6-2
General corrective measures	6-3
Clearing a document jam	6-6
Clearing a recording paper jam	6-7
Maintenance	6-9
Cleaning the microcassette compartment	6-9
Cleaning the document feeder unit	6-10
Cleaning the thermal head	6-10
Printing a test pattern	6-11
Display Indications	6-12
Accessory Order Information	6-13
Specifications	6-13
Index	6-14

When the display shows "E-XX",
see page 6-2 for corrective measures.

Troubleshooting

Error code

If the unit detects a problem, one of the following error codes will appear on the display.

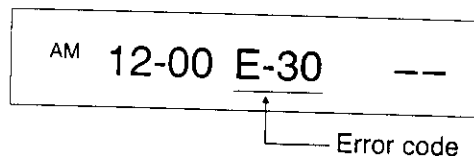

Error Code Table

CODE	CAUSE	REMEDY
02	Interrupted communication.	Retry or check parameters.
03	Document jammed or not fed into the unit properly.	Check document path. If a document is jammed, open the cover, then remove the document. See page 6-6.
04	Transmission or reception error.	Retry the operation.
05	Printing head overheating.	Allow the unit to cool.
06	The unit is out of recording paper.	Check recording paper. See pages 1-10 and 1-11.
07	The cover is open.	Check cover latch.
08	Recording paper jammed.	Open the recording paper unit, then remove the jammed paper. See pages 6-7 and 6-8.
09	Passcode communication failed.	Confirm that your passcode corresponds to that of the other unit. See page 4-9.
20	Memory check error.	Memory (phone numbers, parameters, etc.) has been erased. Reprogram. See pages 1-17 to 1-18 and pages 3-2 to 3-5.
21	Power failed. Call counter shows "--".	Check your messages. See pages 2-11 and 2-12.
30	The greeting message is not recorded.	Record your greeting message. See pages 1-14 and 1-15.
32	The microcassette tape is broken or not installed.	Install a new tape. See page 1-9.

General corrective measures

GENERAL

PROBLEM	CAUSE & REMEDY
I cannot transmit or receive a document or cannot talk.	The line cords are connected incorrectly or not connected. —Confirm the connections. See page 1-8.
The unit does not operate properly.	—Turn the POWER switch off, then turn it on again. See page 1-13.
The ALARM indicator lights.	The covers of the unit are open. —Close them firmly.
The unit does not ring.	The RINGER volume selector is set to the OFF position. —Set the RINGER volume selector to the HIGH or LOW position. See page 1-12.

TRANSMISSION

PROBLEM	CAUSE & REMEDY
The ALARM indicator flashes after transmission.	A transmission error has occurred. —Try again. See page 2-4.
The ALARM indicator lights during transmission.	A document more than 600 mm is being transmitted. —Divide the document so that the length can be shorter than 600 mm. See page 2-2. A document causes a jam. —Remove it, then try again. See page 6-6. The unit has been connected to a line that has special telephone services, such as call waiting. —Connect the unit to a line that does not have such services.
The other party complains that letters on the document are distorted.	If your line has special telephone services such as call waiting, the service may have been activated during the fax reception. —Connect the unit to a line that does not have such services. Another telephone connected to the same line as your unit is connected is hung off. —Hang up and try again.
The other party complains that a dirty pattern or black lines appear on the received documents.	The glass and rollers inside the document feeder unit are dirty. —Clean them. See page 6-10.
The unit does not feed the document properly.	The paper rollers inside the document feeder unit are dirty. —Clean them. See page 6-10.

RECEIVING

PROBLEM	CAUSE & REMEDY
Unable to receive documents.	The recording paper is not installed. —Install the recording paper. See pages 1-10 and 1-11.
Unable to receive documents automatically.	The receive mode of the unit is set to the TEL mode. —Operate the manual reception (see page 2-6) or set the receive mode to ANS/FAX, TEL/FAX or FAX mode. See pages 2-7 and 2-8. Your greeting message may be too long. —Shorten your greeting message (see pages 1-14 and 1-15) or ask the other party to press "*" (ASTERISK) then start to transmit a document. —Set the number of rings to answer to "2". See pages 1-28 to 1-30.
Recording image is faint and I cannot read it well.	The sender transmitted a faint document. —Request the sender to transmit a clearer copy of the document.
The START indicator flashes for about 40 seconds after the unit receives a call automatically, but nothing is recorded.	—The caller hangs up during or immediately after your greeting message plays. This may occur if the disconnected signal is not transmitted from the telephone company's central office.
Problems when receiving international facsimiles.	Your greeting message may be too long. —Shorten your greeting message to 10 seconds or less. See pages 1-14 and 1-15. The RX SPEED may need to be set to 4800 bps. —Call your service center.
Unable to retrieve a document using the polling function.	Your polling password does not correspond to that of the other unit. —Program the correct password. See page 4-6. —The other unit does not provide polled function.
Received or copied image is distorted.	The thermal head is dirty. —Clean it with a cloth moistened with isopropyl rubbing alcohol. See page 6-10.

ANSWERING DEVICE & TELEPHONE

PROBLEM	CAUSE & REMEDY
The Call Counter in the display shows "--".	There has been a power failure. —Confirm whether voice-messages are recorded on the tape or not. See pages 2-11 and 2-12. The microcassette tape was not rewound when the unit was turned on. —Rewind the tape. See page 2-10.
The unit has been set to the ANS/FAX mode, but no voice-messages have been recorded.	The tape is not installed properly or it is broken (cut, worn out or twisted). —Install the tape properly or replace it with a new one. See page 1-9.
When the tape is played, the sound level is low or nothing can be heard.	The speaker volume is low. —Raise the sound level using the VOLUME control. The head in the cassette deck compartment is dirty. —Clean it. See page 6-9.
I have played back all the recorded messages, and I want to record the next call after the last message.	—Leave the unit as it is after hearing the messages.
I cannot retrieve recorded messages from a remote phone.	—Make sure that you use your REMOTE TAD ID number correctly. When you use your REMOTE TAD ID number, press the buttons firmly.
Some voice-messages have not been fully recorded.	The calling party control (CPC) should be set to "B". —Call your service center.
When a caller hangs up after leaving a message, the tape does not stop.	VOX TIME should be set to 4 seconds. —Call your service center.

Clearing a document jam

If an original document becomes jammed in the document feeder unit, the ALARM indicator lights and a long beep is heard. Remove the jammed document by following steps below.

1

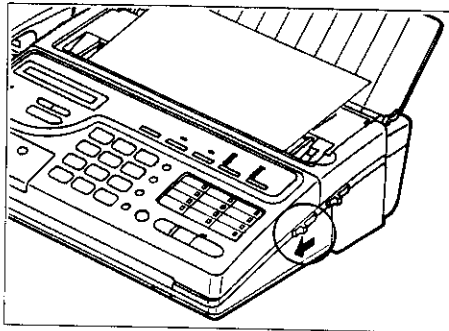

Slide the FRONT LID OPEN lever forward to open the document feeder unit.

2

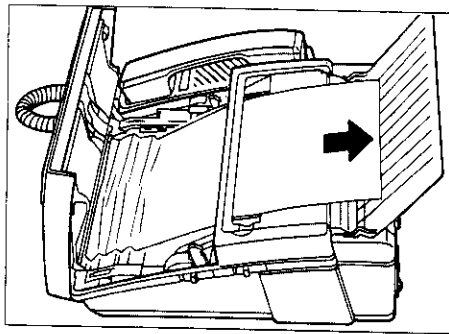

Remove the jammed document carefully.

3

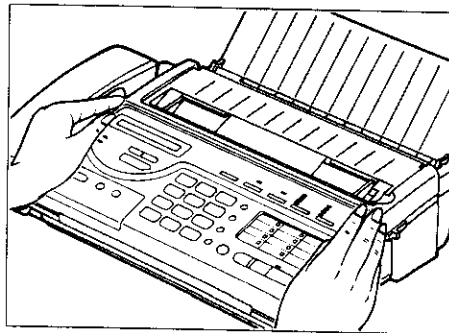

Then close the document feeder unit carefully by pushing down on both ends gently.

Clearing a recording paper jam

When the unit does not eject a recording paper during receiving, the recording paper has jammed. Remove the jammed paper by following the steps below.

1

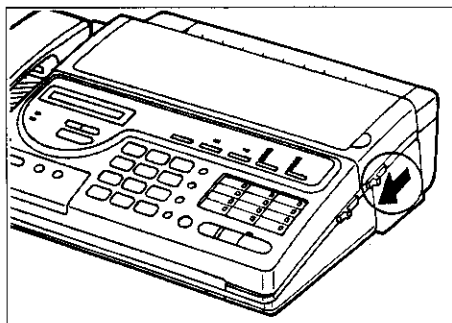

Slide the BACK LID OPEN lever forward to open the recording paper unit.

2

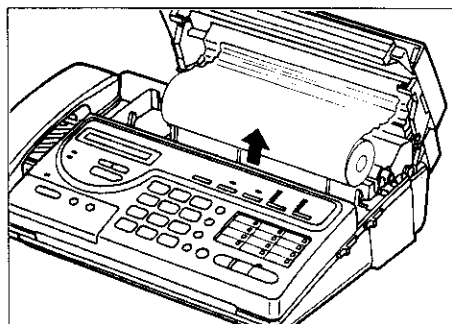

Remove the jammed paper.

3

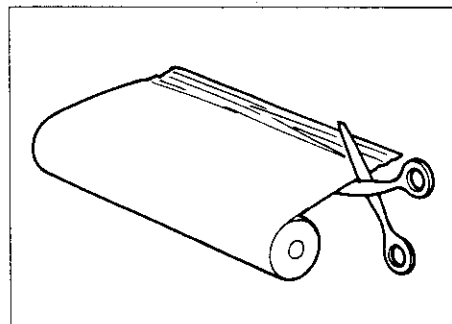

Cut off the wrinkled portion.

4

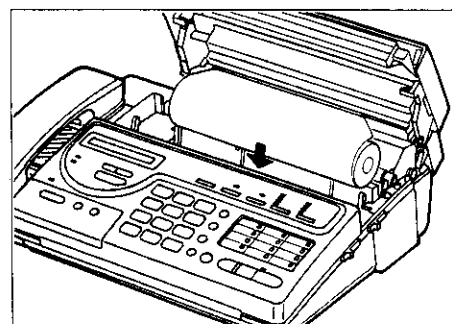

Replace the recording paper roll.

- When re-installing the KX-A101 or a recording paper with 1/2 inch core, remember to fix the paper roll holders to the recording paper.
- Make sure that the shiny side of the paper is facing up and that there is no slack in the paper roll.

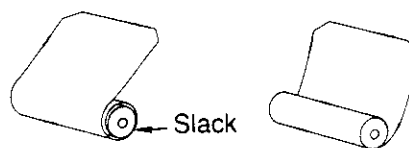

(continued)

Instructions for KX-F2350NZ

5^a

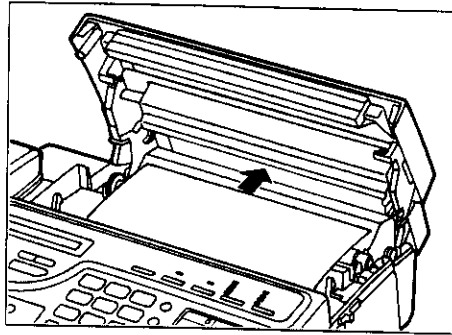

Insert the leading edge of the recording paper into the recording paper exit and pull the paper a few centimeters out of the unit.

6^a

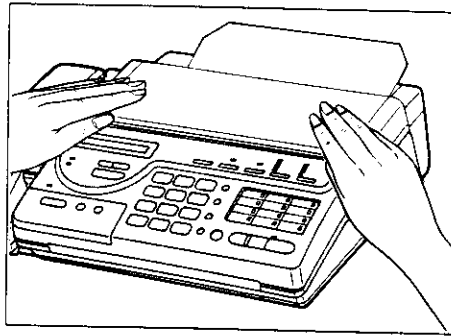

Close the recording paper unit carefully by pushing down on both ends gently.

Instructions for KX-F2450NZ

5^b

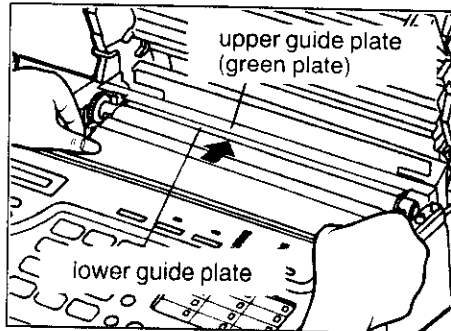

Insert the leading edge of the recording paper between the upper guide plate (green plate) and the lower guide plate. Then pull the paper a few centimeters out of the unit.

If the recording paper cannot be inserted; Close the recording paper compartment cover to reset the paper cutter, then open it by sliding the BACK LID OPEN lever and insert the paper again.

6^b

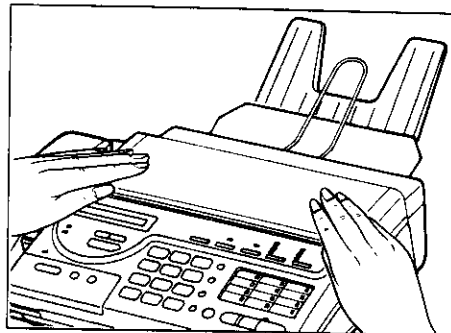

Close the paper compartment cover carefully pushing down on both ends gently.

When the unit is on, the recording paper will project itself slightly and be cut automatically.

Maintenance

Be sure that the AC plug is disconnected from the outlet before performing any maintenance.

Cleaning the microcassette compartment

Dirt and residue from the tape may adhere to the head and capstan causing distortion. Clean these parts periodically in the manner described below for the best sound quality.

1. Open the cassette compartment cover.
2. Remove the microcassette tape.
3. Clean the head surfaces, pinch roller and capstan with a cotton swab.
If these surfaces are extremely dirty, wipe them with a cotton swab dampened with denatured alcohol, then wipe them with a dry soft cloth.

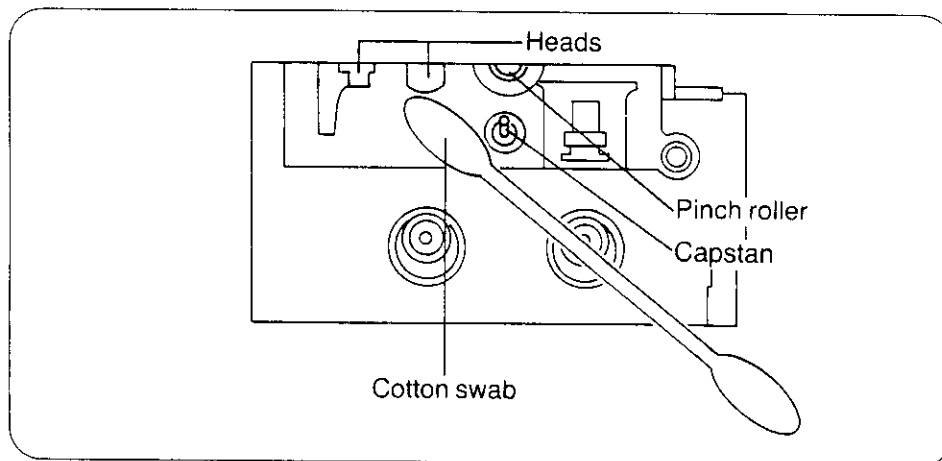

NOTES:

- Do not bring magnetic or metal objects, such as a screwdriver, near the head assembly, as such objects could magnetize the heads.
- Do not oil any part of the unit.

Cleaning the document feeder unit

Clean the inside of the document feeder unit by following the steps below;
—when the unit does not feed the document properly.
—when a dirty pattern or black bands appear on a copied or transmitted document.

1. Turn the **POWER** switch to the "o" (OFF) position and open the document feeder unit.
2. Clean the rubber and the paper rollers rotating them with a cloth moistened with isopropyl rubbing alcohol, then dry thoroughly to prevent paper jams.
3. Clean the glass and the white plate with a dry soft cloth.

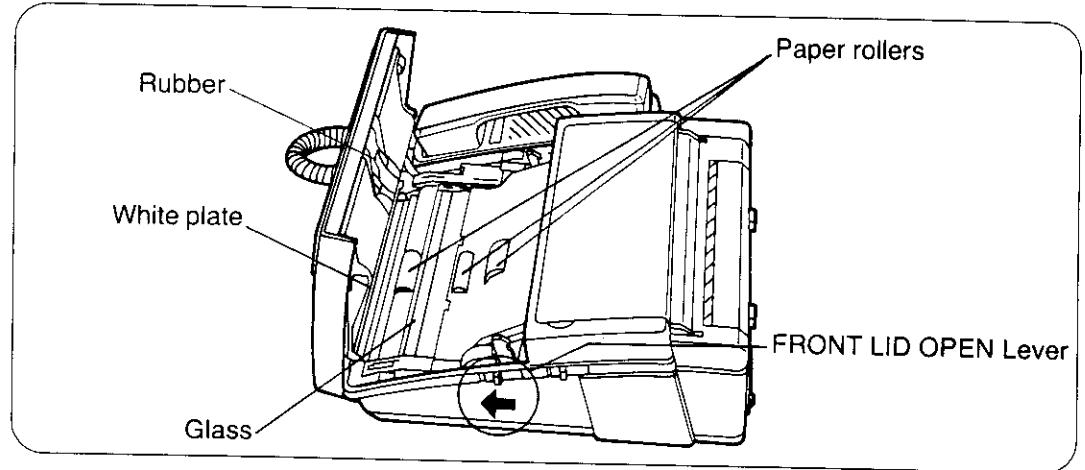

4. Close the document feeder unit and turn the **POWER** switch to the "I" (ON) position.

Cleaning the thermal head

If a dirty pattern or black bands appear on a copied or received document, clean the thermal head inside the recording paper unit by following the steps below.

1. Turn the **POWER** switch to the "o" (OFF) position and open the recording paper unit.
2. Remove the recording paper from the unit.
3. Clean the thermal head with a cloth moistened with isopropyl rubbing alcohol, then dry thoroughly.

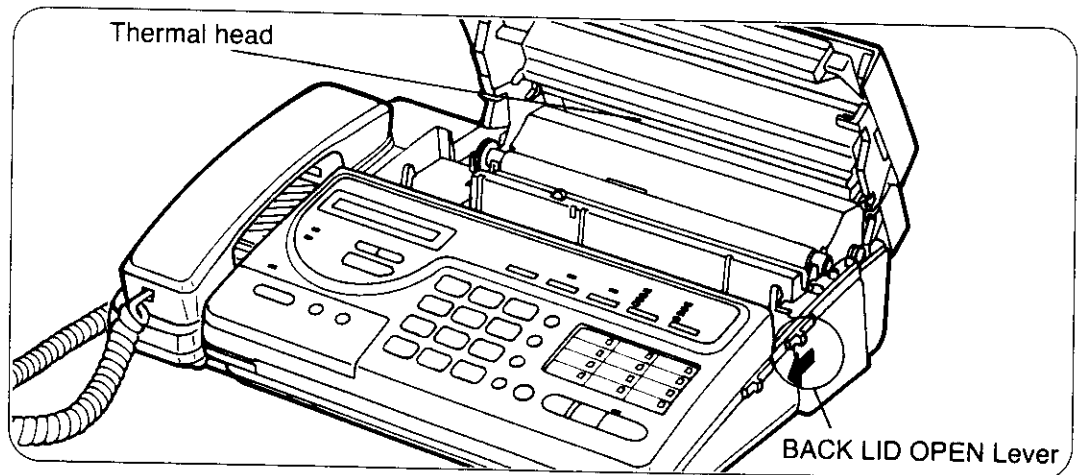

4. Then close the recording paper unit and turn the **POWER** switch to the "I" (ON) position.

NOTES:

- To prevent malfunction due to static electricity, do not use a dry cloth and do not touch the thermal head with your finger directly.
- When finished, confirm the print quality by printing the test pattern. See page 6-11.

Printing a test pattern

You can check the print quality of your unit by printing the test pattern. If the test pattern has any blurred points or lines or a dirty pattern, please clean the thermal head following the instructions on page 6-10.

To obtain the test pattern, follow the steps below.

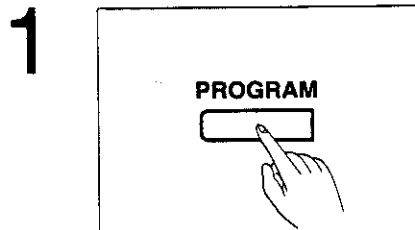

Press the **PROGRAM** button.

The display shows "P- ".

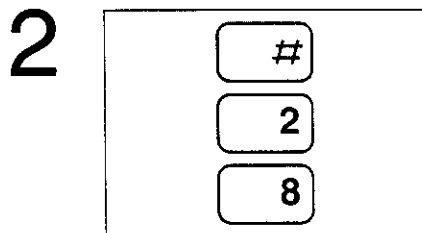

Press #, then press **28**.

The display shows "P-F28".

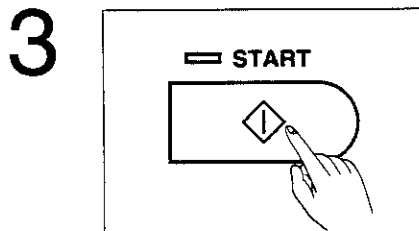

Press the **START** button.

The unit prints the pattern as shown below.

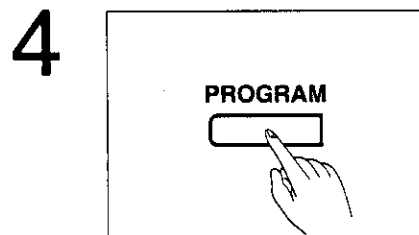

Press the **PROGRAM** button to end the operation.

Sample of test pattern:

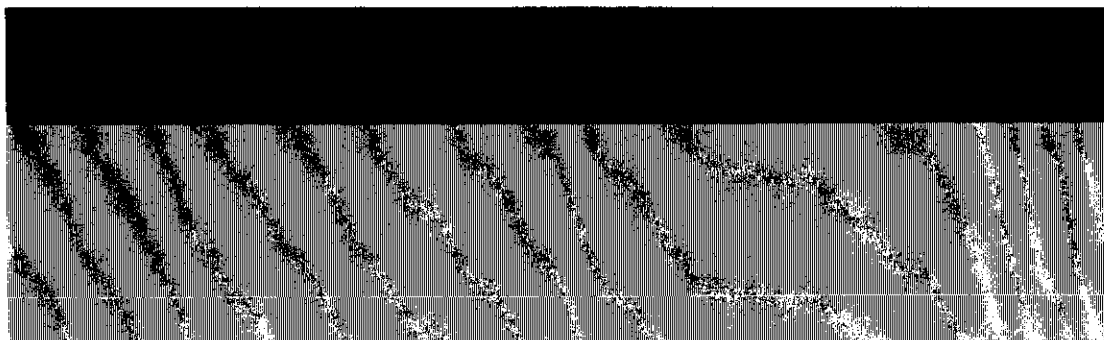

Display Indications

Display	Meaning	Reference Page
AM 9:50 03	Idle status—The current time and number of incoming messages received are displayed. e.g. The current time is 9:50 AM. Three messages have been received.	
AM 9:50 04:30P 03	Idle status—Delayed transmission starting time is displayed. e.g. The delayed transmission will start at 4:30 PM.	4-2 4-3
AM 9:50 E-30 03	An error code is displayed. e.g. The error code is E-30.	6-2
P-05	The number of the page currently being transmitted/received is displayed.	2-4 to 2-8, 4-4 to 4-5
AM 9:50 0000 03	Indicates that the tape is currently being rewound.	2-10 to 2-11
AM 9:50 0000 03	Indicates that the tape is advancing/playing.	2-10 to 2-14
AM 9:50 0000 03	Displayed for 7 seconds after Auto-Logic operation, and for 1 minute after pressing the STOP button during message playback.	2-10 to 2-14
AM 9:50 \ / / 03 0000 / / \	Flashes to indicate that the answering device has entered pause mode as a result of pressing the START button to receive a fax during answering device operation.	
AM 9:50 11 03	Indicates elapsed time. e.g. 11 seconds have elapsed since you began to record a greeting message.	1-15
P-	Indicates that the unit is in program mode awaiting further entry.	1-19
P-001	Indicates that the unit is ready to accept the phone number for an AUTO DIAL station. e.g. The unit is ready to accept the number for AUTO DIAL station 01.	3-4
P-007	Indicates that the unit is ready to accept the phone number for a direct call station. e.g. The unit is ready to accept the number for direct call station 7.	3-3
P-F	Indicates that the unit is in program mode and is awaiting entry of a feature number.	1-19
P-F04 3	Indicates the setting of a feature. e.g. The setting for feature number 04 is 3.	1-19

Accessory Order Information

Replacement parts and accessories are available through your local authorized parts distributor.

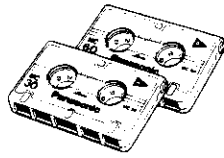
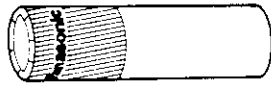
Parts No.	Picture	Description	Comment
MC-30 MC-60		Microcassette Tape	For replacement
KX-A106 KX-A101		Recording Paper 216 mm x 30 m roll KX-A106: 1 inch core KX-A101: 1/2 inch core	For supplement

Specifications

Type:	Desktop
Applicable Lines:	Public Switched Telephone Network
Document Size:	Max. 216 mm in width, Max. 600 mm in length
Effective Scanning Width:	Max. 208 mm
Printing Paper Size:	216 mm (letter) x 30 m roll
Effective Printing Width:	208 mm
Transmission Time*:	Approx. 30 sec/page (G3 Normal mode) Approx. 15 sec/page (Original mode)
Scanning Density:	Horizontal 8 pels/mm (203 pels/inch) Vertical 3.85 lines/mm (98 lines/inch) Standard 7.7 lines/mm (196 lines/inch) Fine/Halftone 15.4 lines/mm (392 lines/inch) Superfine
Scanner Type:	CCD image sensor
Printer Type:	Thermal printing
Data Compression System:	Modified Huffman (MH), Modified Read (MR)
Modem Speed:	9600/7200/4800/2400 bps; Automatic Fallback
Automatic Document Feeder:	Max. 10 sheets
Temperature Range:	5°–35°C
Humidity Range:	45%–85%
Dimensions (H x W x D):	107 x 379 x 297 mm
Weight:	KX-F2350NZ: 5.3 kg KX-F2450NZ: 5.6 kg
Power Consumption:	Approx. 50 W
Power Supply:	AC 220–240 V, 50 Hz

*Transmission Time: Transmission times apply to text data using CCITT No. 1 test chart, between same machine models at maximum modem speed. Transmission times vary in actual usage.

Index

A			
AC Jack		1-3	
AC Outlet		1-8	
AC Power Cord		1-7	
Accessories		1-7	
Activity Report		5-2	
Advanced Feature List		1-18, 5-8	
ALARM Indicator		1-5, 1-13	
ALL MESSAGES Button	1-6, 2-10, 2-12		
Answering device control panel		1-2	
ANS/FAX mode		1-16	
Receiving a document in		2-7	
ANS/FAX RING COUNT		1-17	
Selecting		1-28	
AUTO DIAL Button	1-5, 3-2, 3-4		
Automatic dialer		3-7	
Making Voice Calls Using		3-8	
Transmitting Documents Using		3-7	
Automatic redialing feature		2-5, 3-7	
B			
BACK LID OPEN Lever	1-2, 1-10, 6-7, 6-10		
Back space		4-21	
Basic Feature List		1-17, 5-7	
C			
Call counter		2-10	
Cassette Compartment		1-3	
Character Code Table		1-23	
CHECK Button	1-6, 1-14, 1-15, 2-10		
Cleaning			
Document feeder unit		6-10	
Microcassette compartment		6-9	
Thermal head		6-10	
Combination dialing		4-30	
Copy			
Making		2-9	
COPY Button		1-6	
CUSTOMIZED HEADER		1-18	
Setting		4-15, 4-16	
D			
DAY/NIGHT MODE		1-18	
Setting	4-31, 4-32		
Delayed Transmission	4-2, 4-3		
DELAYED TRANSMISSION		1-18	
DIALING MODE Selector	1-3, 1-12		
Setting		1-12	
Direct Call Station Keys	1-6, 3-2		
Display Indications		6-12	
Diverter	1-7, 1-8		
Document		2-2	
Acceptable		2-2	
Clearing jam of		6-6	
Loading		2-3	
Receiving		2-6, 2-7, 2-8	
Transmitting		2-4, 3-2	
You cannot send		2-2	
Document Feeder Tray		1-2	
E			
Error Code		6-2	
EXTENSION COPY	1-18, 4-18		
F			
FAX mode		1-16	
Receiving a document in		2-8	
FAX RING COUNT		1-17	
Selecting		1-30	
FF (Fast Forward) Button		1-6, 2-10	
FRONT LID OPEN Lever		1-2, 6-10	
G			
Greeting Message		1-14	
Checking		1-15	
Recording		1-15	
Re-recording		4-24	
Skipping for incoming message recording mode		4-23	
H			
Handset		1-7, 1-8	
Handset cord		1-7, 1-8	
HELP Button		1-5	
Using		1-33	
HELP Function		1-33, 1-34	
HYPHEN Key	3-2, 3-3, 3-4		
I			
ICM ERASE Button		1-6, 2-10	
Incoming message		2-11	
Playing back all messages		2-12, 4-20	
Playing back newly recorded messages		2-11, 4-20	
Recording where you want to save		2-12	
J			
JOURNAL AUTO PRINT		1-18	
Setting		5-3	
JOURNAL Report		5-2	
Printing		5-4	
L			
LCD		1-5	
LIGHT ORIGINAL		2-3	
Button and Indicator		1-5	
LINE Jack		1-3	
Connect to		1-8	
List of Stored Phone Numbers		5-5	
Sample of		5-5	

Listing directory card	3-2	PROGRAM Button	1-5, 1-19, 3-2
LOGO POSITION	1-18		
Setting	4-14		
M		R	
MAIN PASSCODE	1-18	REC Button	1-6, 1-14, 1-15, 2-10
Main Passcode	4-9	RECALL Button	1-5, 4-29
Programming	4-9	Recall Mode	1-18, 4-34
Maintenance	6-9	RECEIVE MODE	1-16, 2-7
Memo message	2-13	ANS/FAX mode	1-16, 2-7
Recording	2-13	FAX mode	1-16, 2-8
Memory playback	4-20	TEL mode	1-16
MEMO/2WAY REC Button	1-6, 2-10, 2-13, 2-14	TEL/FAX mode	1-16, 2-8
MESSAGE ALERT	1-18	RECEIVE MODE Button	1-5, 1-16
Setting	4-27	Receiving Tray	1-7, 1-8
MIC (Microphone)	1-14	Reception	
Microcassette compartment	1-3	Automatic	2-7
Cleaning	6-9	Interrupting	2-6
Microcassette tape	1-7	Manual	2-6
Installing	1-9	Recording paper	1-7
Taking off	1-9	Clearing jam of	6-7
MUTE Button and Indicator	1-5	Installing	1-10, 1-11
		RECORDING TIME FOR TAD	1-17
		Changing	1-31
		REDIAL Button	1-5
N		Redialing	2-16
Network Communication	4-7	REMOTE TAD ID	1-17, 4-19, 4-20, 4-23, 4-24
NEW MESSAGES Button	1-6, 2-10, 2-11	Setting the code for	1-32
		Remote control functions	4-19
O		Back space and skip forward	4-21
One touch dialing	3-3	Playing back all messages	4-20
Storing phone numbers for	3-3	Playing back newly recorded messages	4-20
		Recording a marker message	4-21
P		Re-recording a greeting message	4-24
PAPER OUT Indicator	1-5, 1-13	Resetting tape for future messages	4-22
PAPER SAVE FUNCTION	1-18	Skipping the greeting message	4-23
Setting	4-17	REMOTE FAX ACTIVATION CODE	1-18
Paper roll holders	1-7, 1-11	Programming	4-13
Paper rollers	6-10	Resetting setup features	4-35
PAUSE Button	1-5, 4-30	Resetting tape	4-22
Pinch roller	6-9	RESOLUTION	2-3
Polling	4-4	Setting	2-3
Polling another unit	4-4, 4-5	RESOLUTION Button	1-5
POLLING Button and Indicator	1-5, 4-4, 4-5	REW (Rewind) Button	1-6, 2-10, 2-11
POLLING PASSWORD	1-18	RINGER OFF	1-17, 1-28
Setting	4-6	RINGER Volume Selector	1-3
POWER Switch	1-3	Setting	1-12
Turning on	1-13	Rotary pulse dial service (PULSE)	1-12
PRINT ADVANCED FEATURE LIST	1-17	RX PASSCODE CHECK	1-18, 4-7, 4-8
PRINT TRANSMISSION REPORT	1-17	Turning on	4-11
Changing	1-27		
Sample of	1-26	S	
PRINT JOURNAL	1-18	SECRET Key	3-2, 3-5
PRINT TEL LIST	1-18	Secret Phone Numbers	3-5
PRINTER TEST	1-18	Storing	3-5
Printing	6-11	SET Button	1-5, 1-19, 3-2
Printing a test pattern	6-11	SET DATE	1-17
Privacy Ring	4-25	SET DEFAULT	1-18
Calling with	4-26	Setting data and time	1-20, 1-21
PRIVACY RING ID	1-18, 4-25, 4-26	SILENT FAX RECOGNITION RING	1-18
Programming	4-25	Setting	4-33

Skip forward	4-21
Skipping the greeting message for incoming message recording mode	4-23
SP-PHONE (VOICE STDBY) Button and Indicator	1-5, 2-15
Specifications	6-13
Speed dialing	
Station numbers for	3-2
Storing phone numbers for	3-4
START Button and Indicator	1-6, 1-19
STOP Button	1-6, 1-14, 2-10
STOP/CLEAR Button	1-6, 1-19, 2-5, 3-2
T	
TEL mode	1-16
TEL/FAX mode	1-16
Receiving a document in	2-8
Telephone conversation	2-14
Recording	2-14
Telephone line cord	1-7
TELEPHONE NUMBER LIST	5-5
Printing	5-6
Temporary Tone dialing	4-29
Test pattern	6-11
Thermal head	6-10
Cleaning	6-10
TO HANDSET	1-8
Connect to	1-8
Toll Saver	1-28, 1-29
TONE Button	1-5, 4-29
Touch tone service (TONE)	1-12
Transmission	
Interrupting	2-5
Manual	2-4
Using Automatic Dialer	3-7
Troubleshooting	6-2
TX PASSCODE CHECK	1-18, 4-7, 4-8
Turning on	4-10
V	
Voice Contact	4-28
Initiating	4-28
Receiving a request for	4-28
VOLUME Control	1-3, 1-14
VOX	1-14, 1-31
Y	
YOUR LOGO	1-17
Setting	1-22, 1-23
YOUR TELEPHONE NUMBER	1-17
Programming	1-24
# Button	1-19
* Button	4-29
 Indicator	1-5, 2-10, 2-11

FAX CORRESPONDENCE

TO: _____ DATE: _____

FROM: _____ OUR TEL. NO.: _____

We would like to take this opportunity to introduce you to our Panasonic telephone answering device with facsimile. Our unit will work as a facsimile, an answering device and a standard telephone, so you can send both documents and voice-messages on the same call.

Transmitting a voice-message and a document

1. Dial our phone number. Our unit will play the greeting message.
2. Leave your message after the long beep.
3. Press "*" (asterisk) button of your phone after recording your incoming message.
Our unit will switch to the facsimile mode and a fax tone sounds.
4. Start transmission to send a fax after hearing the fax tone.

Transmitting a document only

1. Dial our phone number. Our unit will play the greeting message.
2. Start transmission to send a fax while the greeting message is being played.
 - You may press "*" (asterisk) button while the greeting message is being played. Start transmission after hearing the fax tone.

If you call from a rotary (pulse) phone:

Transmitting a document only

1. Dial our phone number.
Our unit will play the greeting message.
2. Start transmission to send a fax while the greeting message is being played.

Transmitting a document and a voice-message

1. Dial our phone number.
Our unit will play the greeting message.
2. Start transmission to send a fax.
3. Make a call reservation (e.g. ...lift the handset) during transmission of your document.
4. Leave your message after the long beep following the greeting message.

NOTE:

If our unit is in a fax mode, the greeting message is not played and a fax tone sounds. You cannot talk to us, and fax reception is only available.

SPEED DIALER LIST

CODE	NAME	CODE	NAME
00		14	
01		15	
02		16	
03		17	
04		18	
05		19	
06		20	
07		21	
08		22	
09		23	
10		24	
11		25	
12		26	
13		27	

OPERATION FROM TONE PHONE

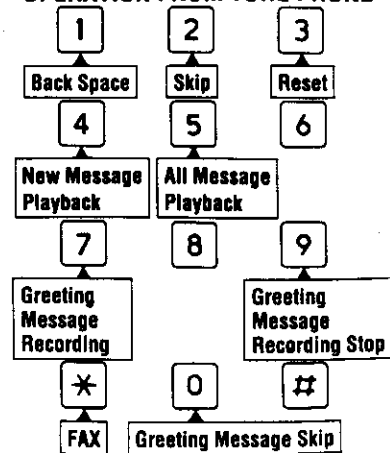

- To set the ANS/FAX mode, call your unit and wait for 15 rings. The unit will answer, then hang up.
- To send the document, press *****. The "beep" (fax tone) is heard. Then start transmission.

SPEED DIALER LIST

CODE	NAME	CODE	NAME
00		14	
01		15	
02		16	
03		17	
04		18	
05		19	
06		20	
07		21	
08		22	
09		23	
10		24	
11		25	
12		26	
13		27	

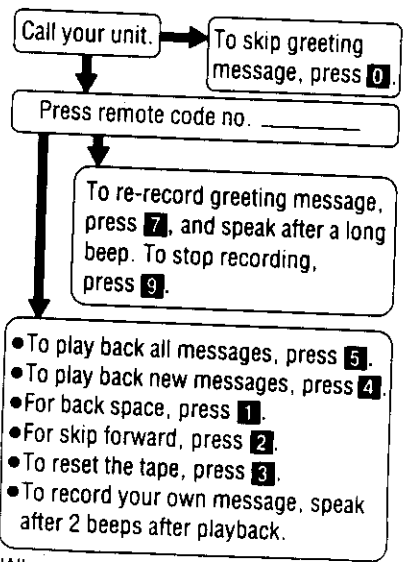

When you press a button, press firmly.